

Side View type chip LED

SML-A10 Series

The SML-A10 series are side view type chip LEDs.

●Features

- 1) Green colored light emission.
- 2) Small shaped (1.6×1.15×0.55mm).

●External dimensions (Units : mm)

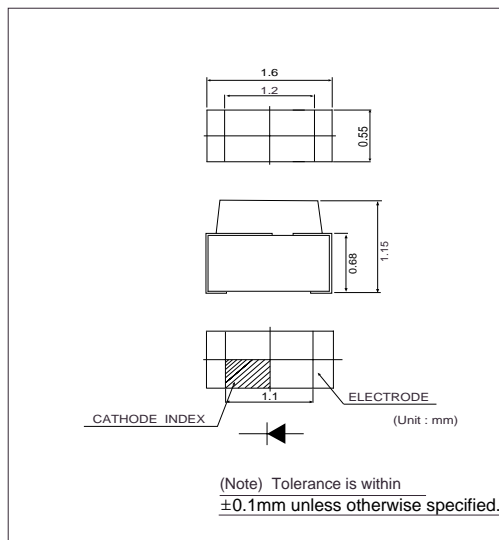

●Selection guide

Emitting color	Green
Lens	
Transparent clear	SML-A10MT

●Absolute maximum ratings (Ta=25°C)

Parameter	Symbol	Limits	Unit
Power dissipation	P _D	55	mW
Forward current	I _F	20	mA
Peak forward current	I _{FP}	60	mA*
Reverse voltage	V _R	4	V
Operating temperature	T _{opr}	-30~+85	°C
Storage temperature	T _{stg}	-40~+85	°C

* Pulse width 1ms Duty 1 / 5

Light Emitting Diodes

●Electrical and optical characteristics (Ta=25°C)

Parameter		Color	Forward voltage			Reverse current			Luminous intensity			Peak wavelength		Spectral line half width	
			V _F (V)		Cond.	I _R (mA)	Cond.	I _V (mcd)		λ _P (nm)	Cond.	Δλ(nm)	Cond.		
Type			Typ.	Max.	I _F (mA)	Max.	V _R (V)	Min.	Typ.	I _F (mA)	Typ.	I _F (mA)	Typ.	I _F (mA)	
SML-A10	MT	Green	2.2	2.8	20	100	4	3.6	10	20	570	20	40	20	

●Directional pattern

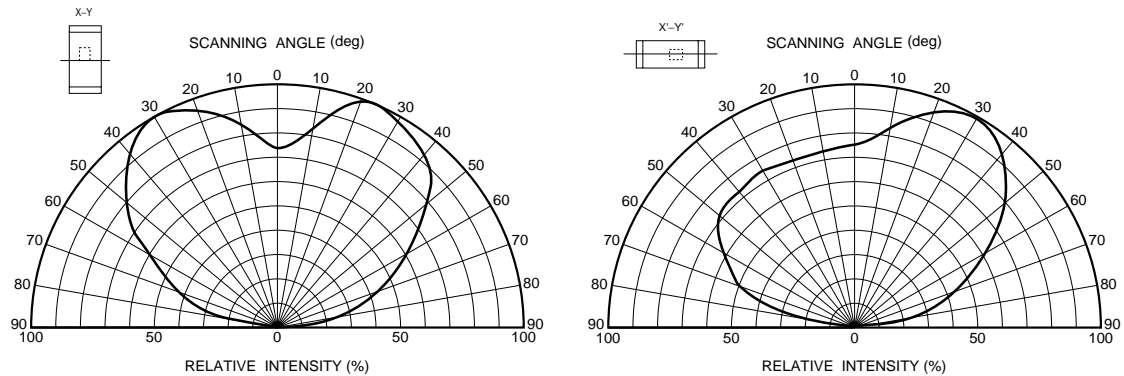

Fig.1 Directional pattern

●Electrical characteristic curves

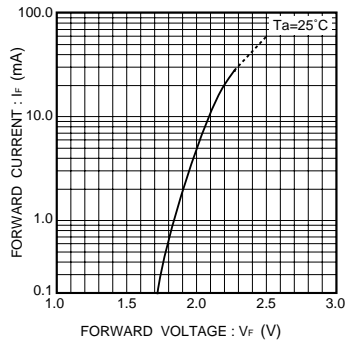

Fig.2 Forward current vs. forward voltage

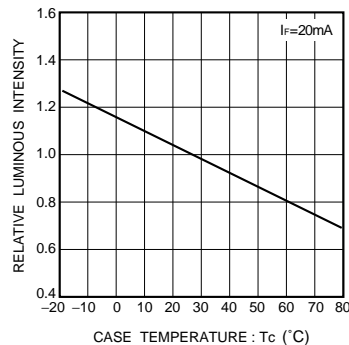

Fig.3 Relative luminous intensity vs. case temperature

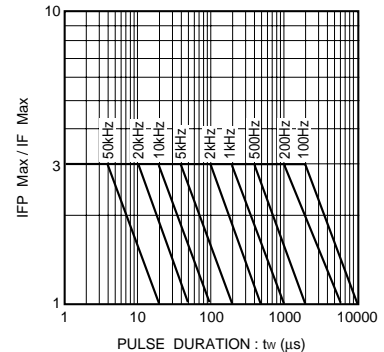

Fig.4 Ratio of maximum tolerable peak current vs. pulse duration

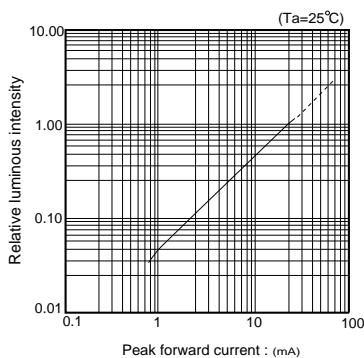

Fig.5 Relative luminous intensity vs. forward current

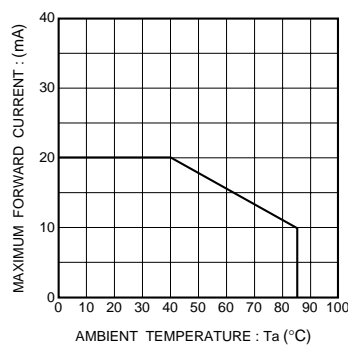

Fig.6 Maximum forward current vs. ambient temperature (Derating)