

EVALUATION KIT
AVAILABLE

MAXIM

1575MHz/1900MHz Variable-IP3 Low-Noise Amplifiers

General Description

The MAX2654/MAX2655/MAX2656 high third-order intercept point (IP3), low-noise amplifiers (LNAs) are designed for applications in GPS, PCS, WLL, and satellite phone systems. The MAX2654/MAX2655/MAX2656 incorporate on-chip internal output matching to 50Ω, eliminating the need for external matching components. A shutdown feature in the MAX2654/MAX2655 reduces the operating current to 0.1μA, eliminating the need for an external supply switch.

The MAX2654 operates in the GPS frequency of 1575MHz with 15.1dB of gain, 1.5dB noise figure, and only consumes 5.8mA. The MAX2655 is designed with high-input IP3 to improve operation in cellular applications where the cellular power amplifier leaks into the GPS receiver. The MAX2656 is designed for PCS phone applications with 13.5dB of gain in high-gain mode and 0.8dB of gain in low-gain mode (selected by a logic control) and 1.9dB noise figure.

The IP3 of MAX2655/MAX2656 is adjustable by a single external bias resistor (R_{BIAS}), allowing supply current to be optimized for a specific application.

The MAX2654/MAX2655/MAX2656 operate from a +2.7V to +5.5V single supply and are available in the miniature 6-pin SC70 package.

Applications

GPS Receivers
GPS Receivers in Cellular Phones
DCS/PCS Cellular Phones
Satellite Phones
Wireless Local Loop

Pin Configuration

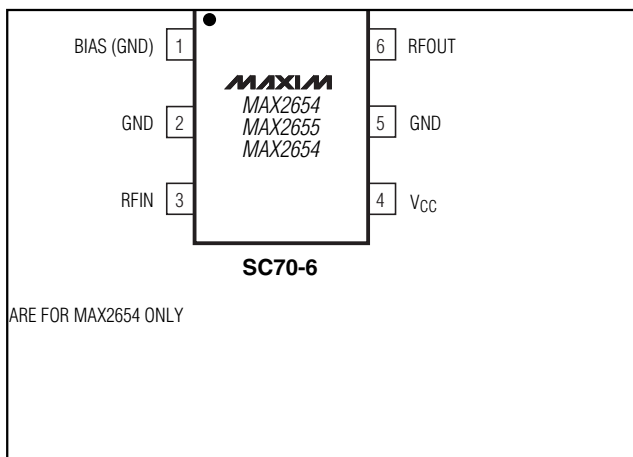

Features

- ◆ Low Noise Figure
 - MAX2654: 1.5dB at 1575MHz
 - MAX2655: 1.45dB at 1575MHz
 - MAX2656: 1.9dB at 1960MHz
- ◆ High Gain
 - MAX2654: 15.1dB at 1575MHz
 - MAX2655: 14.1dB at 1575MHz
 - MAX2656: 13.5dB at 1960MHz
- ◆ 12.7dB Gain Step (MAX2656 only)
- ◆ Integrated 50Ω Output Matching
- ◆ Variable IP3 Set by One Bias Resistor (MAX2655/MAX2656 only)
- ◆ 0.1μA Shutdown Mode (MAX2654/MAX2655 only)
- ◆ +2.7V to +5.5V Single-Supply Operation
- ◆ Ultra-Small 6-Pin SC70 Package

Ordering Information

PART	TEMP RANGE	PIN-PACKAGE	SOT TOP-MARK
MAX2654EXT-T	-40°C to +85°C	6 SC70-6	AAI
MAX2655EXT-T	-40°C to +85°C	6 SC70-6	AAJ
MAX2656EXT-T	-40°C to +95°C	6 SC70-6	AAK

Typical Operating Circuit

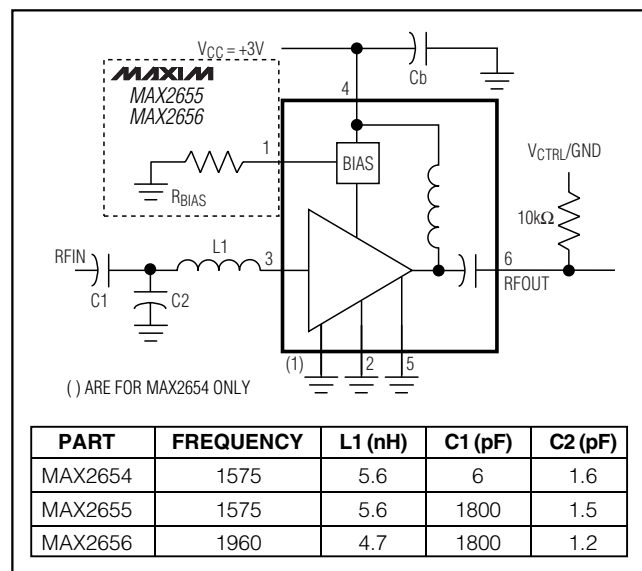

MAXIM

Maxim Integrated Products 1

For pricing, delivery, and ordering information, please contact Maxim/Dallas Direct! at 1-888-629-4642, or visit Maxim's website at www.maxim-ic.com.

MAX2654/MAX2655/MAX2656

1575MHz/1900MHz Variable-IP3 Low-Noise Amplifiers

ABSOLUTE MAXIMUM RATINGS

V _{CC} to GND	-0.3V to +6V	Operating Temperature Range	-40°C to +85°C
RF Input Power	+5dBm	Maximum Junction Temperature	+150°C
Continuous Power Dissipation (T _A = +70°C)		Storage Temperature	-65°C to +150°C
6-Pin SC70 (derate 3.1mW/°C above +70°C)	245mW	Lead Temperature (soldering, 10s)	+300°C

Stresses beyond those listed under "Absolute Maximum Ratings" may cause permanent damage to the device. These are stress ratings only, and functional operation of the device at these or any other conditions beyond those indicated in the operational sections of the specifications is not implied. Exposure to absolute maximum rating conditions for extended periods may affect device reliability.

DC ELECTRICAL CHARACTERISTICS

(V_{CC} = +2.7V to +5.5V, R_{BIAS} = 511Ω ±1%, T_A = -40°C to +85°C. No RF signal applied. R_{FIN} is AC-coupled and terminated to 50Ω. R_{FOUT} is unconnected. Typical values are at V_{CC} = +3V, T_A = +25°C, unless otherwise noted.) (Note 1)

PARAMETER	CONDITIONS		MIN	TYP	MAX	UNIT
Supply Voltage			2.7		5.5	V
Operating Supply Current (MAX2654 only)	V _{RFOUT} = V _{CC}	T _A = +25°C		5.8	8.2	mA
		T _A = -40°C to +85°C			9.2	
	V _{RFOUT} = GND	T _A = +25°C		0.1	1	μA
		T _A = -40°C to +85°C			2.1	
Operating Supply Current (MAX2655 only)	V _{RFOUT} = V _{CC} T _A = +25°C	R _{BIAS} = 511Ω ±1%		8.3	10	mA
		R _{BIAS} = 698Ω ±1%		5.9		
		R _{BIAS} = 357Ω ±1%		10.1		
		R _{BIAS} = 511Ω ±1%, T _A = -40°C to +85°C			11.1	
	V _{RFOUT} = GND	T _A = +25°C		0.1	1	μA
		T _A = -40°C to +85°C			2.2	
Operating Supply Current (MAX2656 only)	V _{RFOUT} = GND T _A = +25°C	R _{BIAS} = 511Ω ±1%		11.5	15.2	mA
		R _{BIAS} = 715Ω ±1%		8.5		
		R _{BIAS} = 511Ω ±1%, T _A = +85°C			13.6	
	V _{RFOUT} = V _{CC}	T _A = +25°C			12.3	mA
		T _A = +85°C			14.6	
	Input Logic High at V _{RFOUT}	(Note 2)		2		
Input Logic Low at V _{RFOUT}	(Note 3)				0.6	V
Input Logic High Current at V _{RFOUT} (Note 4)	MAX2654/MAX2655				15.6	μA
	MAX2656				71	
Input Logic Low Current at V _{RFOUT} (Note 5)	MAX2654/MAX2655				1	μA
	MAX2656				-24	

1575MHz/1900MHz Variable-IP3 Low-Noise Amplifiers

MAX2654/MAX2655/MAX2656

AC ELECTRICAL CHARACTERISTICS (MAX2654)

(MAX2654 Evaluation Kit, $V_{CC} = +3.0V$, $P_{IN} = -30dBm$, $f_{IN} = 1575MHz$, $V_{RFOUT} = V_{CC}$ through a 10k Ω resistor, $T_A = +25^{\circ}C$. Typical values are at $V_{CC} = +3V$, $T_A = +25^{\circ}C$, unless otherwise noted.) (Note 6)

PARAMETER	CONDITIONS	MIN	TYP	MAX	UNIT
Operating Frequency Range (Note 7)		1400		1700	MHz
Gain	(Note 8)	12.7	15.1		dB
Gain Variation Over Temperature	$T_A = -40^{\circ}C$ to $+85^{\circ}C$		0.15	1	dB
Input Third-Order Intercept Point (Note 9)			-7.2		dBm
Input 1dB Compression Point			-18		dBm
Noise Figure (Note 10)			1.5	1.8	dB
Input Return Loss			9.7		dB
Output Return Loss			8.4		dB
Reverse Isolation			30		dB

AC ELECTRICAL CHARACTERISTICS (MAX2655)

(MAX2655 Evaluation Kit, $V_{CC} = +3.0V$, $P_{IN} = -30dBm$, $f_{IN} = 1575MHz$, $V_{RFOUT} = V_{CC}$ through a 10k Ω resistor, $R_{BIAS} = 511\Omega \pm 1\%$, $T_A = +25^{\circ}C$. Typical values are at $V_{CC} = +3V$, $T_A = +25^{\circ}C$, unless otherwise noted.) (Note 6)

PARAMETER	CONDITIONS	MIN	TYP	MAX	UNIT
Operating Frequency Range (Note 7)		1400		1700	MHz
Gain	(Note 8)	12	14.1		dB
Gain Variation Over Temperature	$T_A = -40^{\circ}C$ to $+85^{\circ}C$		0.6	1.1	dB
Input Third-Order Intercept Point (Note 9)	$R_{BIAS} = 511\Omega \pm 1\%$		2.8		dBm
	$R_{BIAS} = 698\Omega \pm 1\%$		2.2		
	$R_{BIAS} = 357\Omega \pm 1\%$		3.8		
Input 1dB Compression Point			-12.2		dBm
Noise Figure (Note 10)			1.45	1.9	dB
Input Return Loss			16.1		dB
Output Return Loss			15.5		dB
Reverse Isolation			32		dB

1575MHz/1900MHz Variable-IP3 Low-Noise Amplifiers

AC ELECTRICAL CHARACTERISTICS (MAX2656)

(MAX2656 Evaluation Kit, $V_{CC} = +3V$, $P_{IN} = -30dBm$, $f_{IN} = 1960MHz$, $V_{RFOUT} = GND$ through a $12k\Omega$ resistor, $R_{BIAS} = 511\Omega \pm 1\%$, $T_A = +25^\circ C$. Typical values are at $V_{CC} = +3V$, $T_A = +25^\circ C$, unless otherwise noted.) (Note 6)

PARAMETER	CONDITIONS	MIN	TYP	MAX	UNIT
Operating Frequency Range (Note 7)		1800		2000	MHz
Gain, High-Gain Mode	(Note 11)	12	13.5		dB
Gain, Low-Gain Mode	(Note 12)		0.8		dB
Gain Variation Over Temperature	$T_A = -40^\circ C$ to $+85^\circ C$		0.3	1.2	dB
Gain Step			12.7		dB
Input Third-Order Intercept Point (Note 13)	$R_{BIAS} = 511\Omega \pm 1\%$		1.5		dBm
	$R_{BIAS} = 715\Omega \pm 1\%$		-3		
	Low-gain mode (Note 12)		7.2		
Input 1dB Compression Point	High-gain mode (Note 11)		-7		dBm
	Low-gain mode (Note 12)		-1.2		
Noise Figure (Note 10)	High-gain mode (Note 11)		1.9	2.4	dB
	Low-gain mode (Note 12)		10.8		
Input Return Loss	High-gain mode (Note 11)		14.4		dB
	Low-gain mode (Note 12)		19.3		
Output Return Loss	High-gain mode (Note 11)		10.7		dB
	Low-gain mode (Note 12)		7.3		
Reverse Isolation	High-gain mode (Note 11)		28		dB
	Low-gain mode (Note 12)		25		
Gain Step Response Time			3.2		μs

- Note 1:** Devices are production tested at $T_A = +25^\circ C$. Minimum and maximum values are guaranteed by design and characterization over temperature and supply voltages to ± 6 sigma.
- Note 2:** Minimum DC voltage through a $10k\Omega$ resistor that sets the MAX2654/MAX2655 to operate in normal mode and MAX2656 in low-gain mode.
- Note 3:** Maximum DC voltage through a $10k\Omega$ resistor that sets the MAX2654/MAX2655 to operate in shutdown mode and MAX2656 in high-gain mode.
- Note 4:** DC current required when V_{RFOUT} is connected to V_{CC} through a $10k\Omega$ resistor.
- Note 5:** DC current required when V_{RFOUT} is connected to GND through a $10k\Omega$ resistor.
- Note 6:** Guaranteed by design and characterization to ± 3 sigma.
- Note 7:** The part has been characterized at the specified frequency range. Operation outside of this range is possible, but not guaranteed.
- Note 8:** Production tested at $T_A = +25^\circ C$.
- Note 9:** Measured with two input tones, $f_1 = 1570MHz$, $f_2 = 1580MHz$, both at $-30dBm$ per tone.
- Note 10:** Excludes PC board losses of $0.2dB$ for MAX2654/MAX2655 and $0.25dB$ for MAX2656.
- Note 11:** High-gain mode is set up by connecting RFOUT to GND through a $12k\Omega$ resistor.
- Note 12:** Low-gain mode is set up by connecting RFOUT to V_{CC} through a $12k\Omega$ resistor.
- Note 13:** Measured with two input tones, $f_1 = 1955MHz$, $f_2 = 1965MHz$, both at $-30dBm$ per tone.

1575MHz/1900MHz Variable-IP3 Low-Noise Amplifiers

Typical Operating Characteristics

($P_{IN} = -30\text{dBm}$, input and output are terminated to 50Ω , $V_{CC} = +3\text{V}$, high-gain and low-gain modes are applicable only to the MAX2656, $T_A = +25^\circ\text{C}$, unless otherwise noted.)

MAX2654/MAX2655/MAX2656

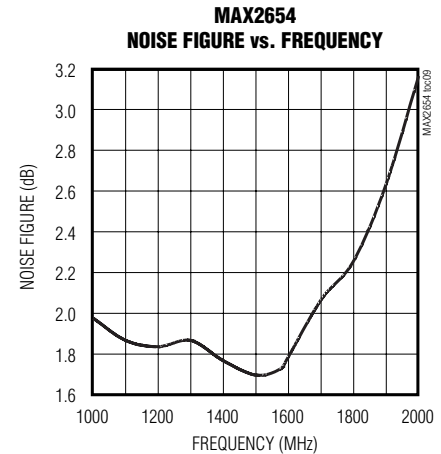
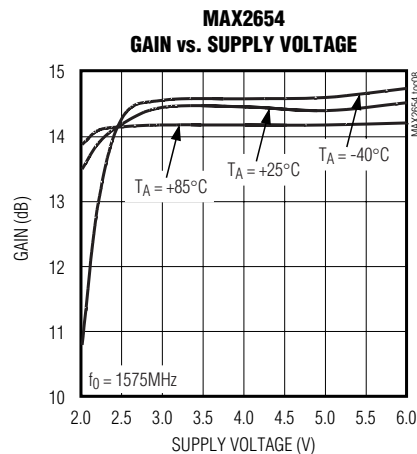
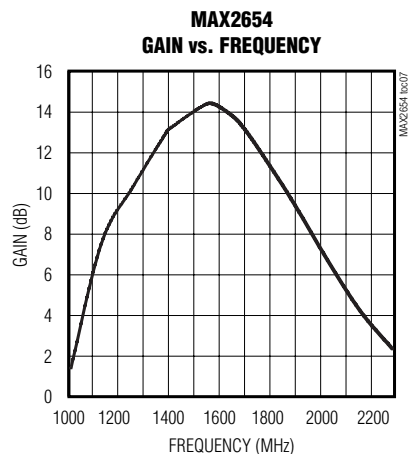
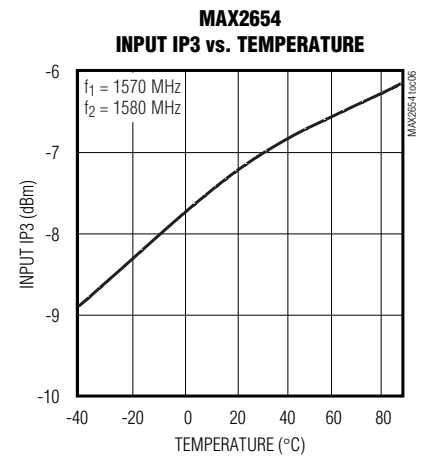
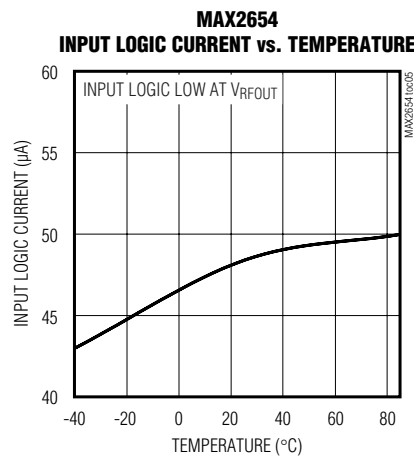
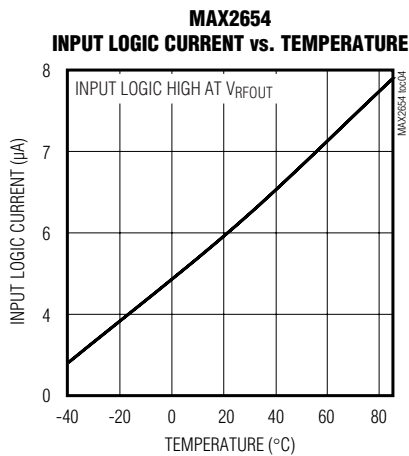
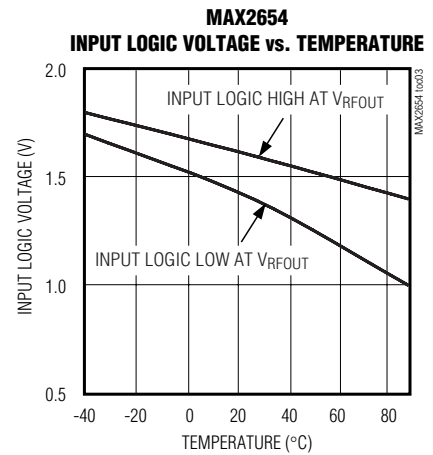
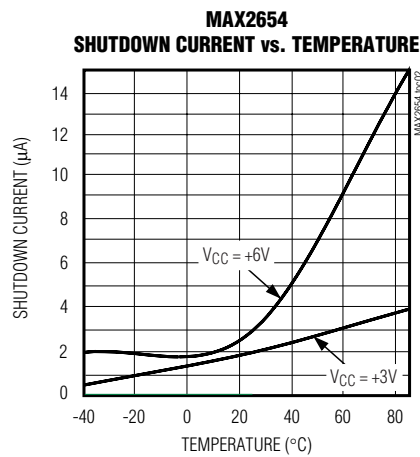
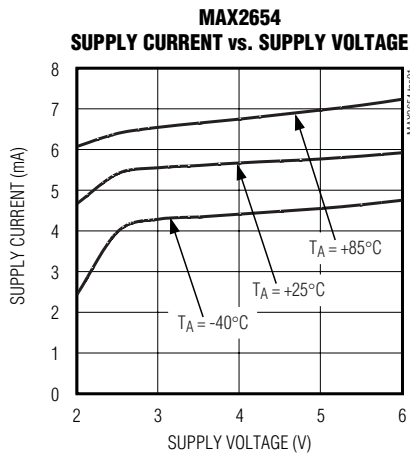

1575MHz/1900MHz Variable-IP3 Low-Noise Amplifiers

Typical Operating Characteristics (continued)

($P_{IN} = -30\text{dBm}$, input and output are terminated to 50Ω , $V_{CC} = +3\text{V}$, high-gain and low-gain modes are applicable only to the MAX2656, $T_A = +25^\circ\text{C}$, unless otherwise noted.)

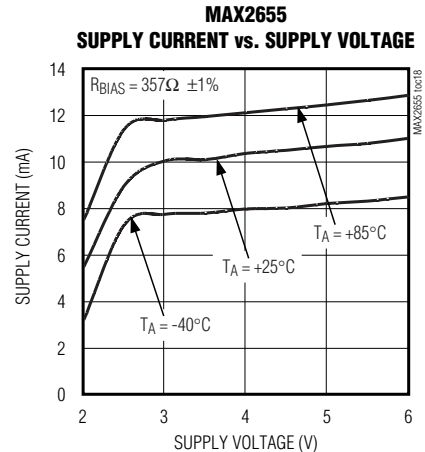
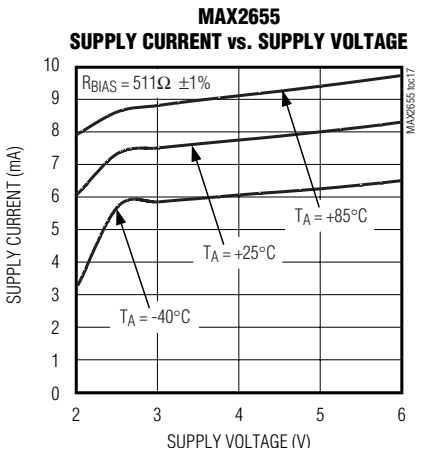
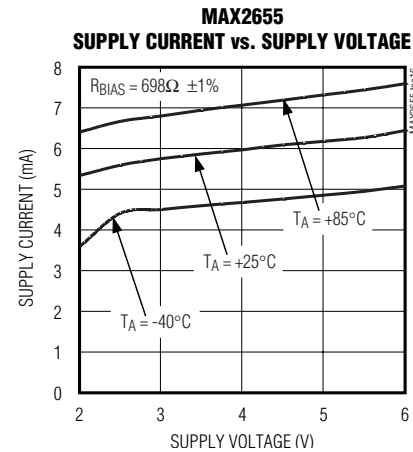
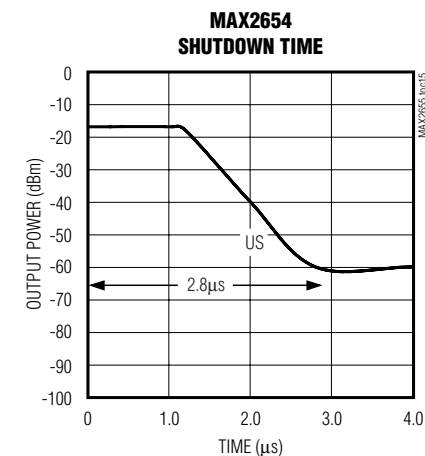
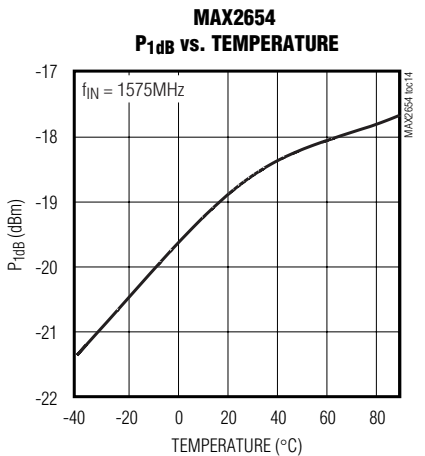
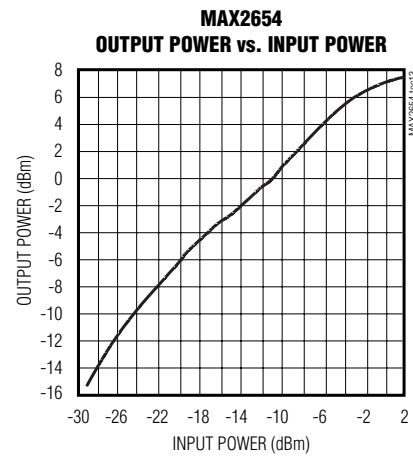
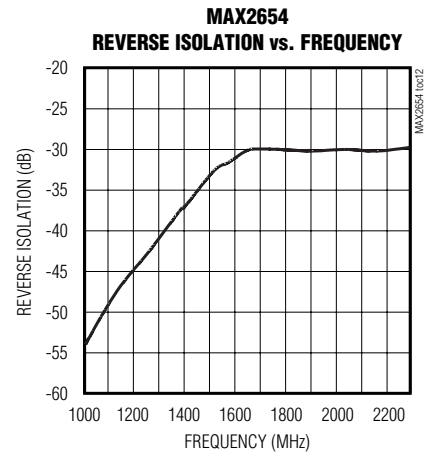
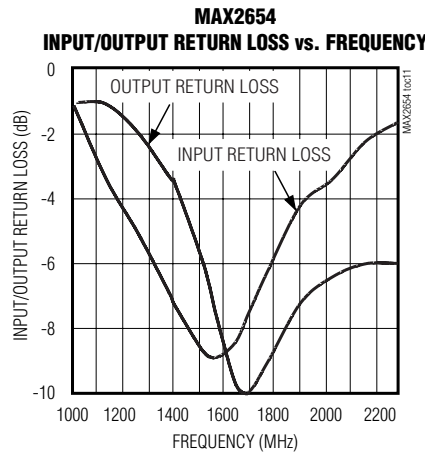
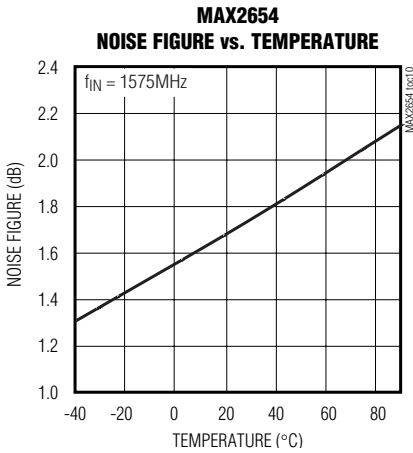

1575MHz/1900MHz Variable-IP3 Low-Noise Amplifiers

MAX2654/MAX2655/MAX2656

Typical Operating Characteristics (continued)

($P_{IN} = -30\text{dBm}$, input and output are terminated to 50Ω , $V_{CC} = +3\text{V}$, high-gain and low-gain modes are applicable only to the MAX2656, $T_A = +25^\circ\text{C}$, unless otherwise noted.)

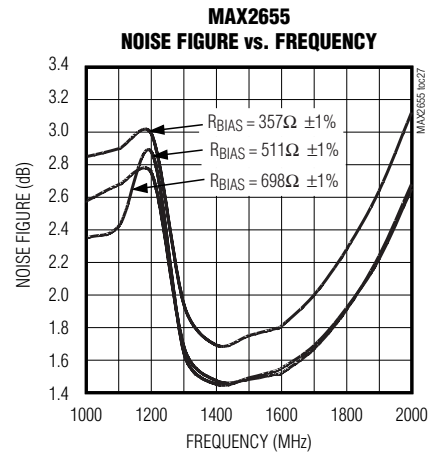
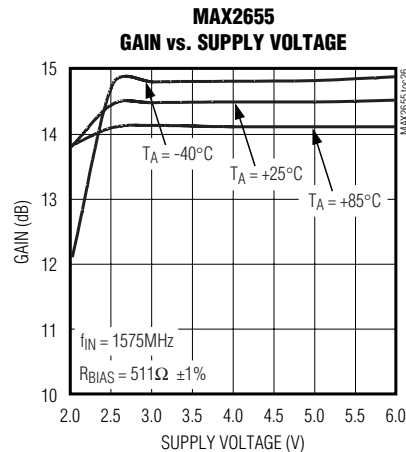
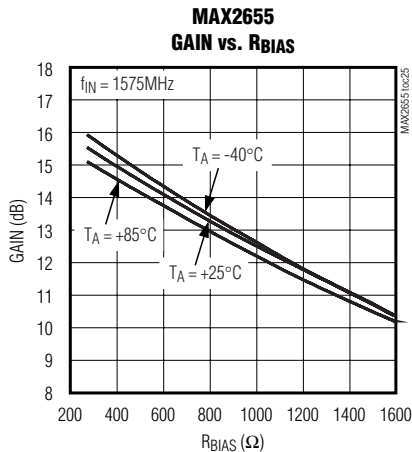
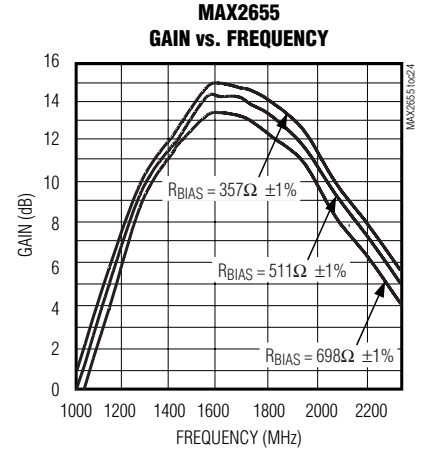
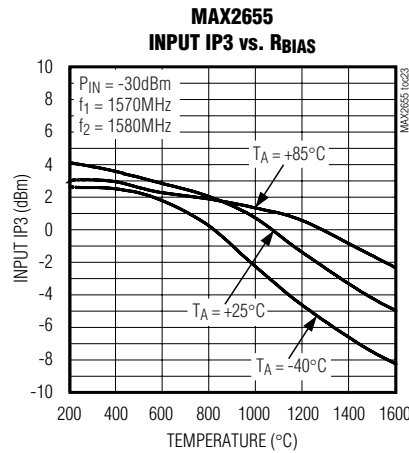
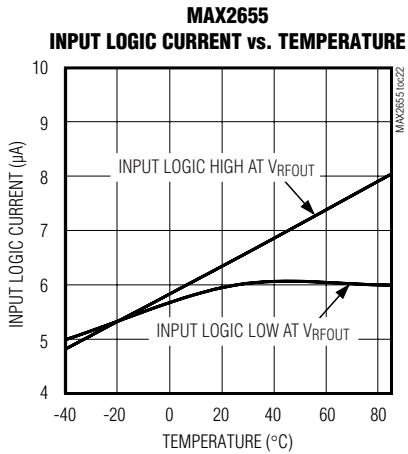
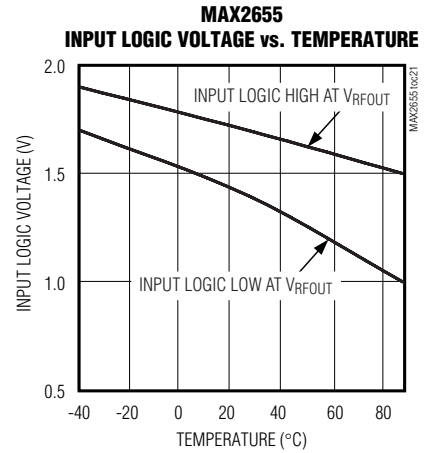
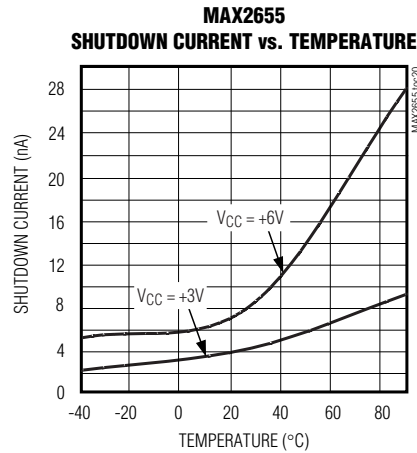
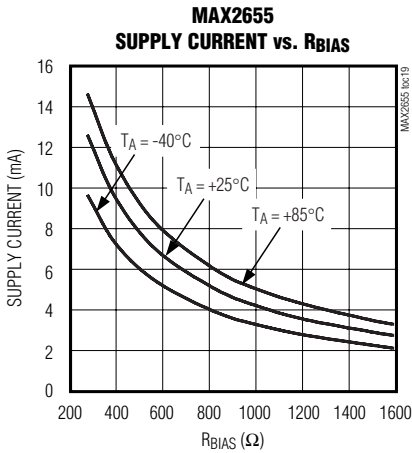

1575MHz/1900MHz Variable-IP3 Low-Noise Amplifiers

Typical Operating Characteristics (continued)

($P_{IN} = -30\text{dBm}$, input and output are terminated to 50Ω , $V_{CC} = +3\text{V}$, high-gain and low-gain modes are applicable only to the MAX2656, $T_A = +25^\circ\text{C}$, unless otherwise noted.)

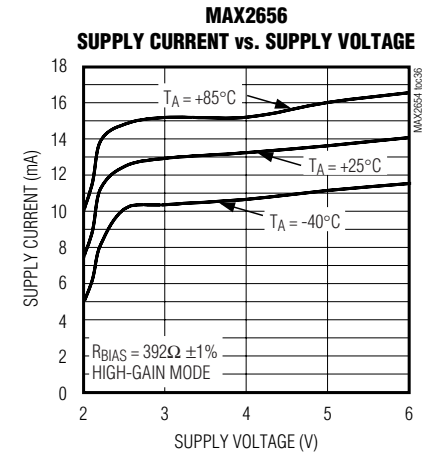
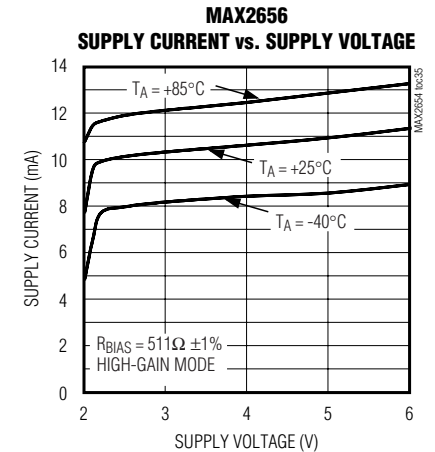
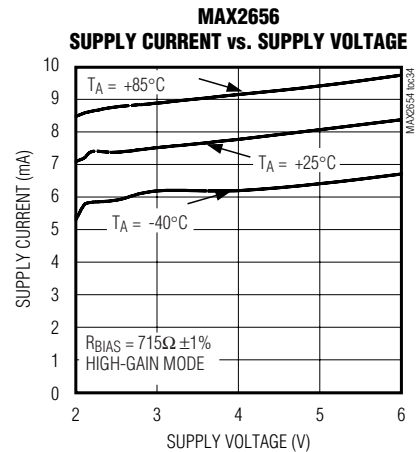
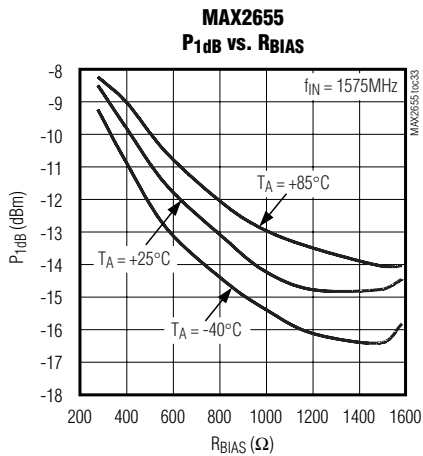
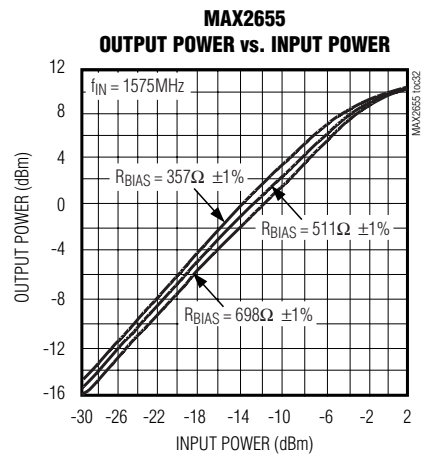
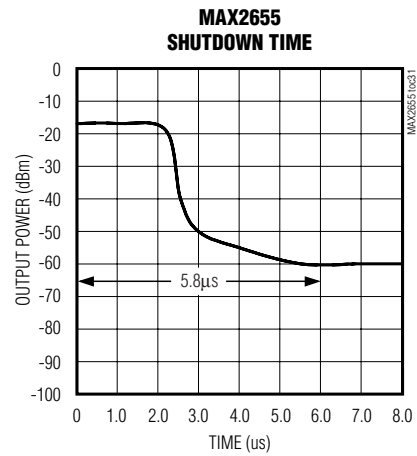
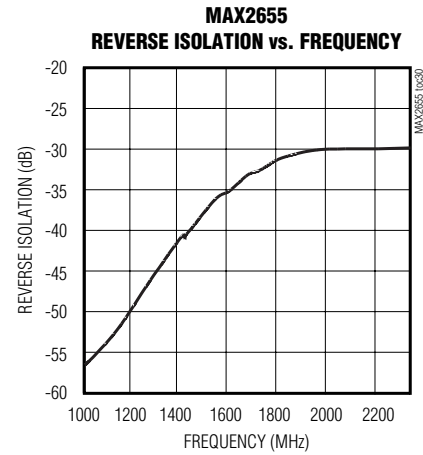
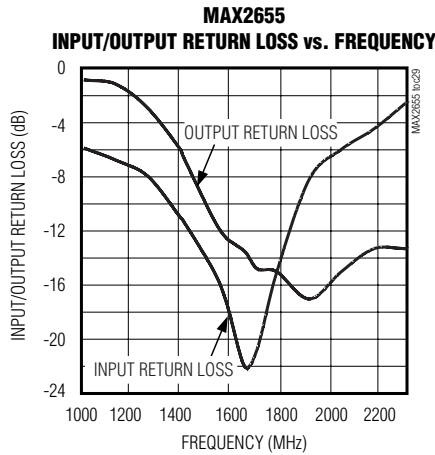
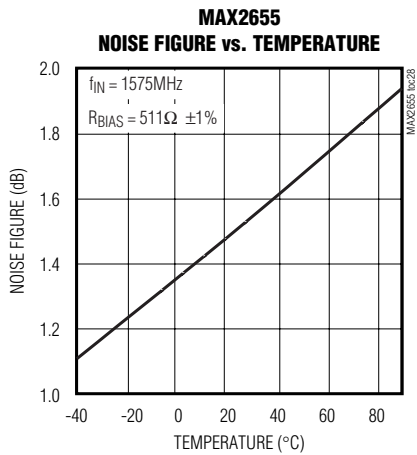

1575MHz/1900MHz Variable-IP3 Low-Noise Amplifiers

Typical Operating Characteristics (continued)

($P_{IN} = -30\text{dBm}$, input and output are terminated to 50Ω , $V_{CC} = +3\text{V}$, high-gain and low-gain modes are applicable only to the MAX2656, $T_A = +25^\circ\text{C}$, unless otherwise noted.)

MAX2654/MAX2655/MAX2656

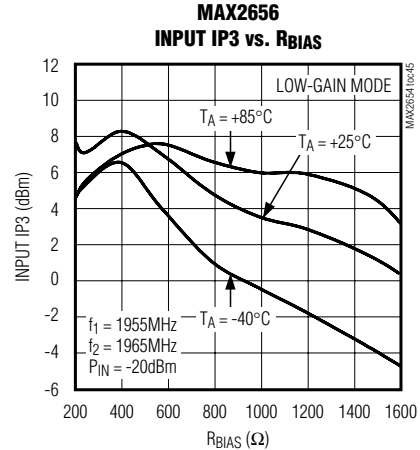
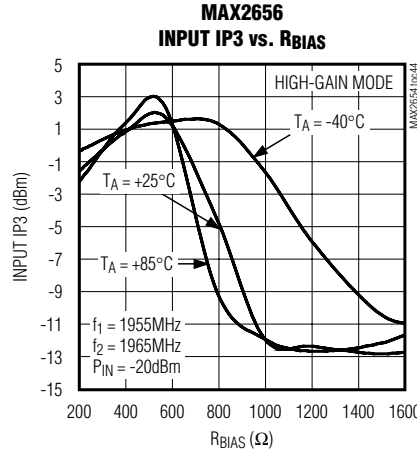
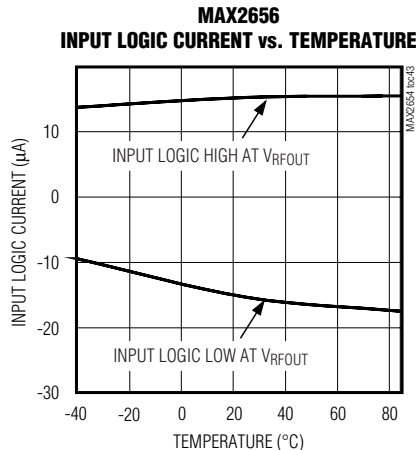
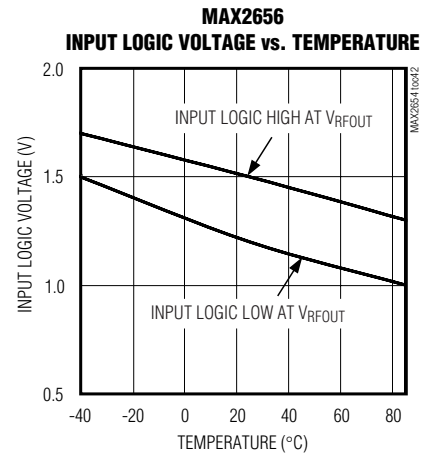
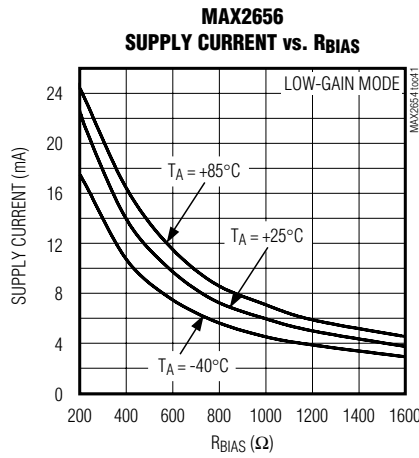
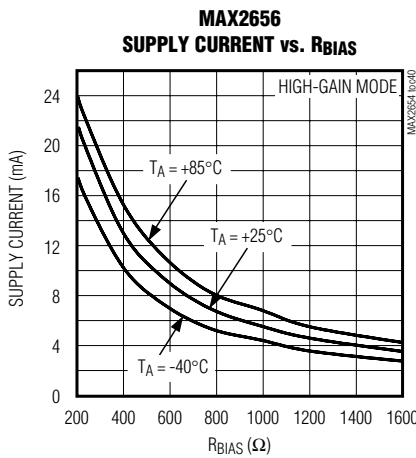
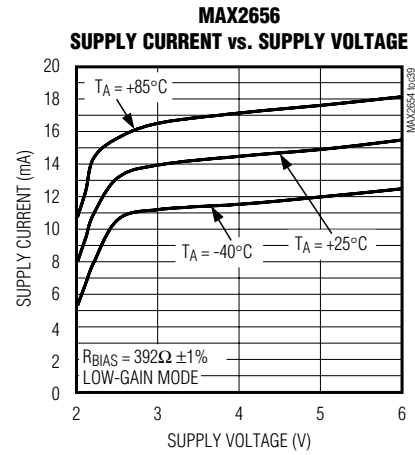
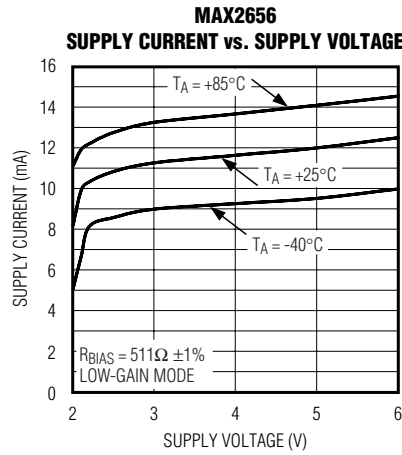
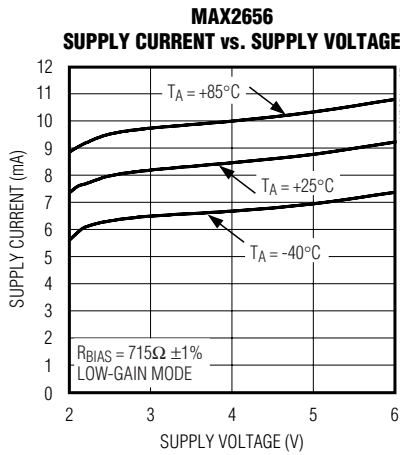

1575MHz/1900MHz Variable-IP3 Low-Noise Amplifiers

Typical Operating Characteristics (continued)

($P_{IN} = -30\text{dBm}$, input and output are terminated to 50Ω , $V_{CC} = +3\text{V}$, high-gain and low-gain modes are applicable only to the MAX2656, $T_A = +25^\circ\text{C}$, unless otherwise noted.)

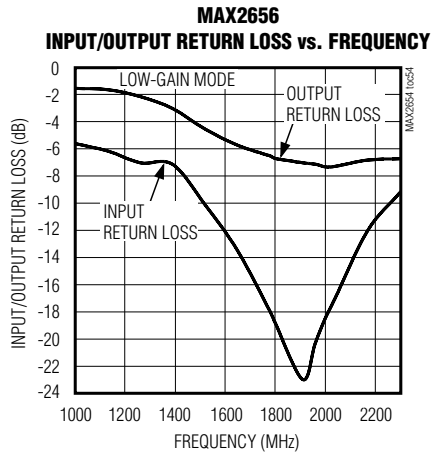
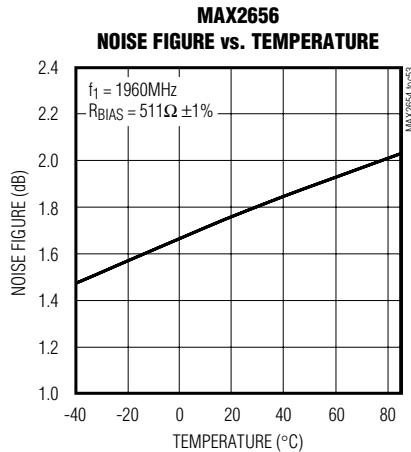
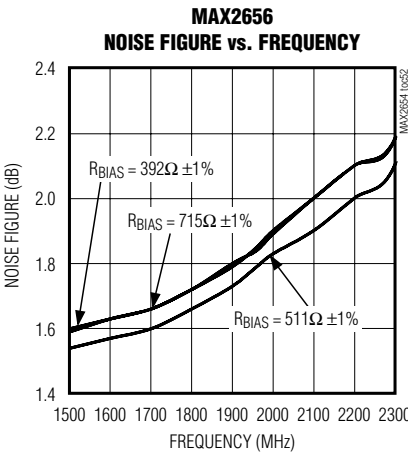
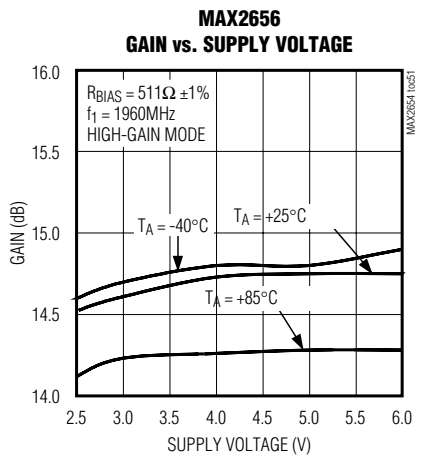
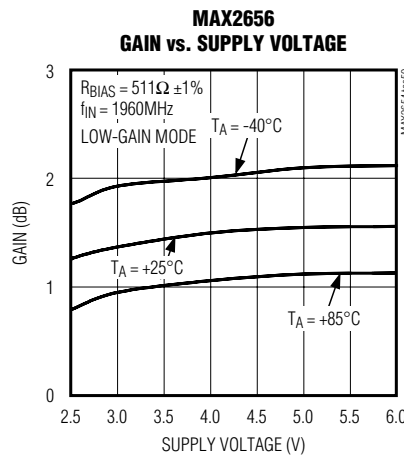
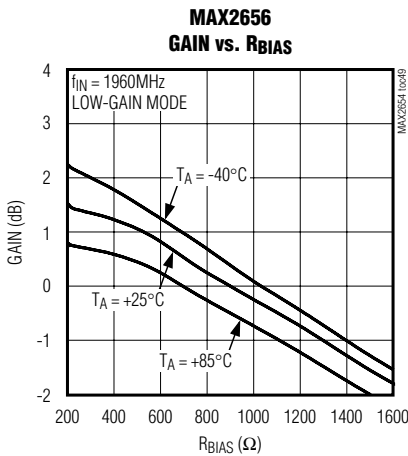
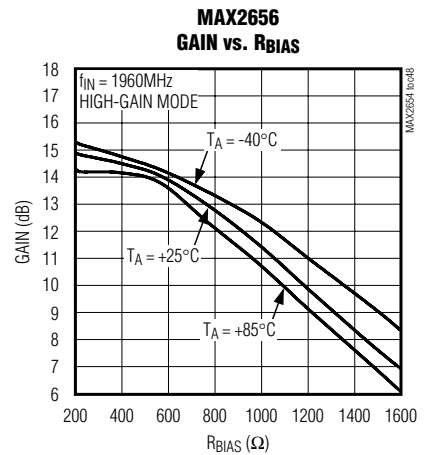
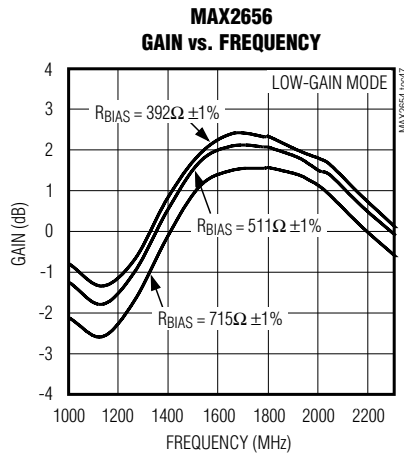
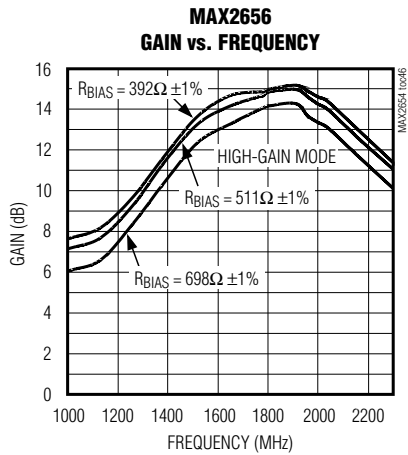

1575MHz/1900MHz Variable-IP3 Low-Noise Amplifiers

Typical Operating Characteristics (continued)

($P_{IN} = -30\text{dBm}$, input and output are terminated to 50Ω , $V_{CC} = +3\text{V}$, high-gain and low-gain modes are applicable only to the MAX2656, $T_A = +25^\circ\text{C}$, unless otherwise noted.)

MAX2654/MAX2655/MAX2656

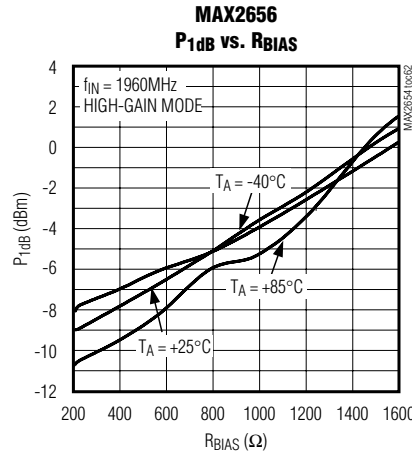
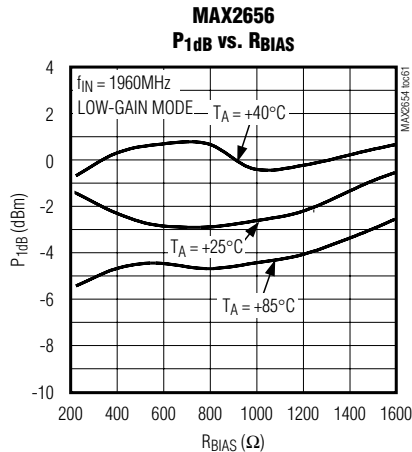
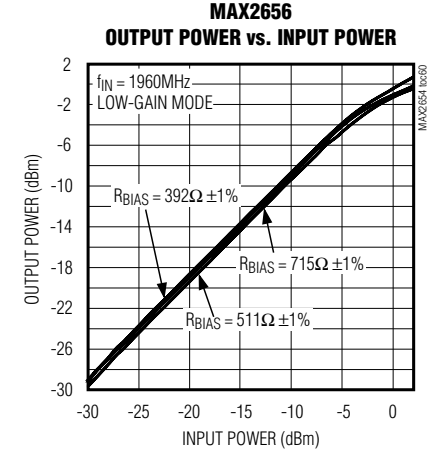
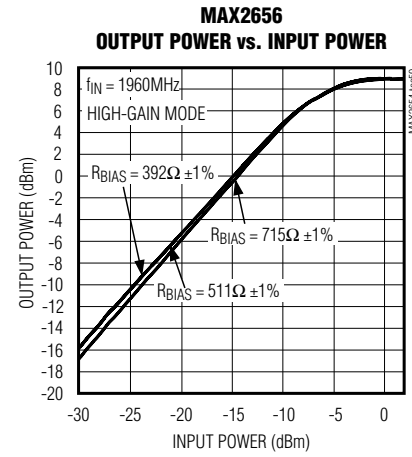
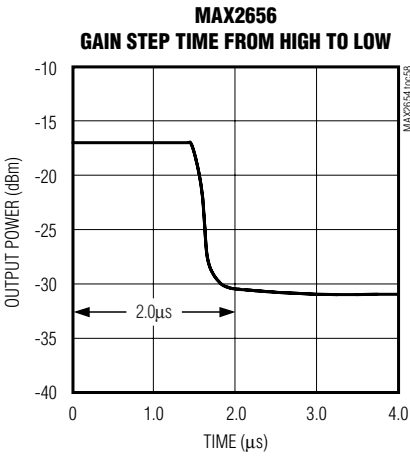
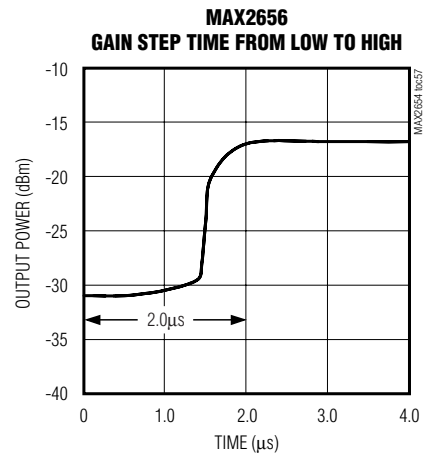
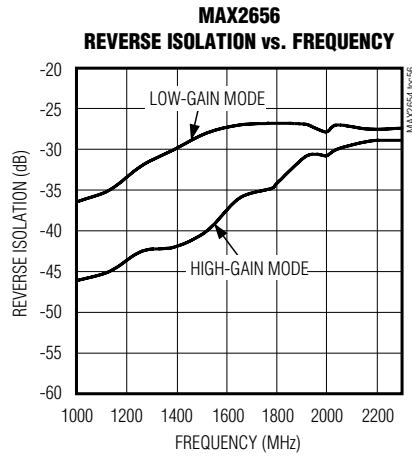
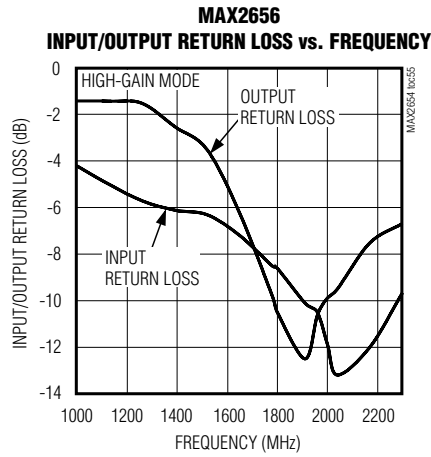

1575MHz/1900MHz Variable-IP3 Low-Noise Amplifiers

Pin Description

PIN		NAME	DESCRIPTION
MAX2654	MAX2655/ MAX2656		
1	—	GND	Ground. Connect to the PC board ground plane through a 0.017in x 0.035in line.
2, 5	2, 5	GND	Ground. Connect to the PC board ground plane with as low an inductance path as possible.
—	1	BIAS	Bias Control. Connect a resistor R_{BIAS} from BIAS to GND. R_{BIAS} sets IP3 and supply current.
3	3	RFIN	Amplifier Input. Requires a DC-blocking capacitor and external matching components.
4	4	VCC	Supply Voltage. Bypass to ground with an appropriate capacitor as close to the IC as possible. Refer to MAX2654/MAX2655/MAX2656 EV kits for capacitor values.
6	6	RFOUT	RF Output. Incorporates an internal DC-blocking capacitor. RFOUT is internally matched to 50 Ω . DC bias on this pin selects gain mode (MAX2656) or shutdown mode (MAX2654/MAX2655) (see <i>Applications Information</i>).

Detailed Description

The MAX2654/MAX2655/MAX2656 are low-noise amplifiers designed for applications in GPS receivers, satellite and PCS phones. The MAX2655/MAX2656 feature variable IP3s, adjusted by a single external bias resistor. Another feature of the MAX2654/MAX2655 is a power shutdown control mode, eliminating the need for an external supply switch. The MAX2656 features a high- and low-gain control mode selected by an external logic control.

Input and Output Ports

The MAX2654/MAX2655/MAX2656 incorporate on-chip matching networks to 50 Ω at the output ports, eliminating the need for external matching components. (For MAX2655, a shunt inductor is recommended for best output return loss. Refer to the MAX2655 EV kit schematic.) The MAX2654/MAX2655/MAX2656 require simple matching networks at the input ports. The values of these matching components are recommended in the *Typical Operating Circuit*.

Variable IP3

The IP3 of MAX2655 and MAX2656 is adjusted through an external resistor (R_{BIAS}). Tables 1 and 2 summarize the values of R_{BIAS} for different IP3s for MAX2655 and MAX2656.

Table 1. R_{BIAS} vs. IP3 for MAX2655

R_{BIAS} (Ω)	IP3 (dBm)	I _{CC} (mA)
698	2.2	5.8
357	3.8	10.1

Table 2. R_{BIAS} vs. IP3 for MAX2656

R_{BIAS} (Ω)	IP3 (dBm)	I _{CC} (mA)
715	-3	8.5
511	1.5	11.5

Gain-Step Control (MAX2656)

The DC bias voltage at RFOUT of the MAX2656 serves as a gain-step control input. When the applied DC voltage at RFOUT through a 10k Ω resistor is less than +0.6V, the device is in high-gain mode. When the applied DC voltage is greater than +2.0V, the device gain is attenuated by 13dB. A standard logic output can be applied as shown in the *Typical Operating Circuit*.

Shutdown-Enable (MAX2654/MAX2655)

The DC bias voltage at RFOUT of the MAX2654/MAX2655 serves as a shutdown enable input. When the applied DC voltage at RFOUT through a 10k Ω resistor is less than +0.6V, the device is in shutdown mode. When the DC voltage is greater than +2V, the device is enabled.

1575MHz/1900MHz Variable-IP3 Low-Noise Amplifiers

Applications Information

Input Matching

For optimum performance, input matching is required. The MAX2654/MAX2655/MAX2656 require a simple LC matching network. The *Typical Operating Circuit* shows the recommended input matching networks. These values are optimized for best simultaneous gain, noise figure, and return loss performance. S-Parameter data can be found on the Maxim website at www.maxim-ic.com.

Layout Issues

A properly designed PC board is essential to any RF-microwave circuit. Use controlled impedance lines on all high-frequency inputs and outputs. Bypass VCC with decoupling capacitors located close to the device. For

long VCC lines, it may be necessary to add decoupling capacitors. Locate these additional capacitors further away from the device package. Proper grounding of the GND pins is essential. If the PC board uses a topside RF ground, connect it directly to all GND pins. For a board where the ground plane is not on the component layer, connect the GND pins to the board with a multiple vias close to the package.

For MAX2654, connect Pin1 to the PC board ground plane through a 0.017in x 0.035in line.

Chip Information

TRANSISTOR COUNT: 135
(Same for MAX2654, MAX2655, MAX2656)

MAX2654/MAX2655/MAX2656

1575MHz/1900MHz Variable-IP3 Low-Noise Amplifiers

Package Information

(The package drawing(s) in this data sheet may not reflect the most current specifications. For the latest package outline information, go to www.maxim-ic.com/packages.)

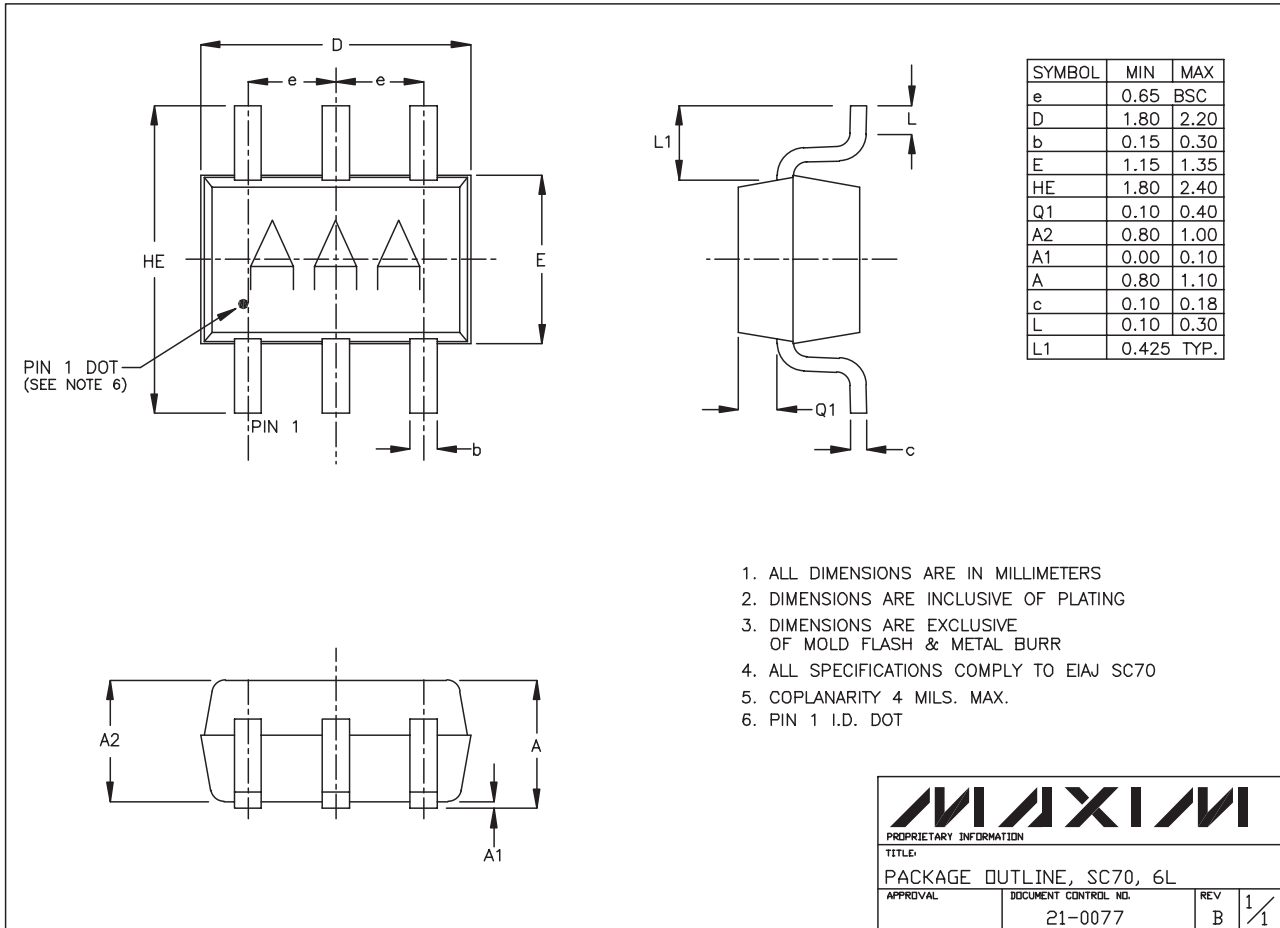

1. ALL DIMENSIONS ARE IN MILLIMETERS
2. DIMENSIONS ARE INCLUSIVE OF PLATING
3. DIMENSIONS ARE EXCLUSIVE OF MOLD FLASH & METAL BURR
4. ALL SPECIFICATIONS COMPLY TO EIAJ SC70
5. COPLANARITY 4 MILS. MAX.
6. PIN 1 I.D. DOT

MAXIM
 PROPRIETARY INFORMATION
 TITLE:
 PACKAGE OUTLINE, SC70, 6L
 APPROVAL: _____ DOCUMENT CONTROL NO. 21-0077 REV B 1/1

Maxim cannot assume responsibility for use of any circuitry other than circuitry entirely embodied in a Maxim product. No circuit patent licenses are implied. Maxim reserves the right to change the circuitry and specifications without notice at any time.

14 _____ **Maxim Integrated Products, 120 San Gabriel Drive, Sunnyvale, CA 94086 408-737-7600**