

# Triple/Dual-Mode CDMA LNA/Mixers

**MAX2338**

## General Description

The MAX2338 receiver RF front-end IC is designed for dual-band CDMA cellular phones and can also be used in dual-band TDMA, GSM, or EDGE cellular phones. Thanks to the MAX2338's on-chip low-power LO divider, the cellular VCO module can be eliminated.

The MAX2338 includes a low-noise amplifier (LNA) with an adjustable high-input third-order intercept point (IIP3) to minimize intermodulation and cross-modulation in the presence of large interfering signals. For cellular band operation, a low-gain LNA is available for higher cascaded IIP3 at lower current.

The CDMA mixers are designed for high linearity, low noise, and differential IF outputs. The FM mixer is designed for lower current and single-ended output.

The MAX2338 triple-mode LNA/mixer includes an on-chip LO frequency divider to allow the use of a single VCO for both bands. This device is available in an ultra-small 28-pin leadless QFN package.

## Applications

Dual-Band, Triple-Mode PCS/Cellular Phones  
Dual-Mode Cellular Phones

*Typical Operating Circuit appears at end of data sheet.*

## Features

- ◆ 1.4dB LNA Noise Figure
- ◆ 15dB LNA Gain
- ◆ Mixer Noise Figure
  - 7.5dB (CDMA)
  - 8.7dB (AMPS)
- ◆ Mixer Gain
  - 14.5dB PCS
  - 13.3dB Cellular
  - 8.8dB AMPS
- ◆ LO Frequency Divider, Saves VCO Module
- ◆ LO Output Buffers for TX
- ◆ Ultra-Small 28-Pin Leadless Package

## Ordering Information

| PART       | TEMP RANGE     | PIN-PACKAGE |
|------------|----------------|-------------|
| MAX2338EGI | -40°C to +85°C | 28 QFN      |

## Pin Configuration/ Functional Diagram

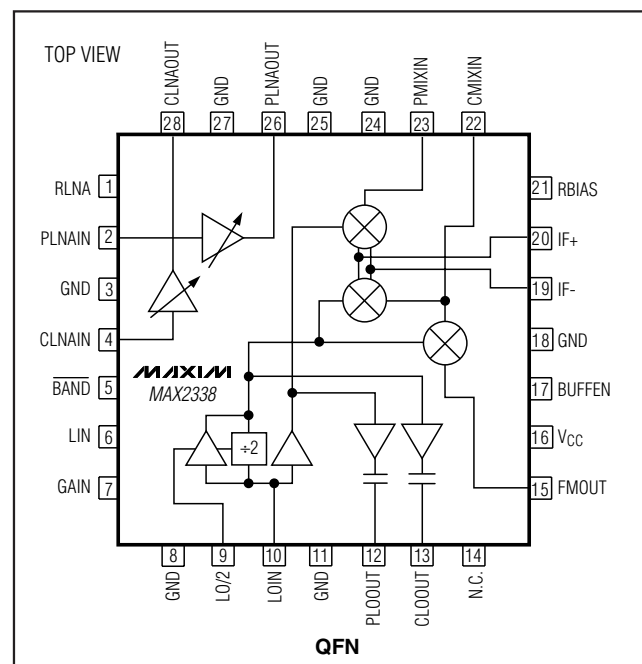

# Triple/Dual-Mode CDMA LNA/Mixers

## ABSOLUTE MAXIMUM RATINGS

V<sub>CC</sub> to GND .....+0.3V to +4.3V  
 Digital Input Voltage to GND .....-0.3V to (V<sub>CC</sub> + 0.3V)  
 LNA Input Level.....1V peak  
 LO, Mixer Input Levels .....+5dBm  
 Digital Input Current .....±10mA  
 Continuous Power Dissipation (T<sub>A</sub> = +70°C)  
 28-Pin QFN (derate 28.5mW/°C above T<sub>A</sub> = +70°C).....2W

Operating Temperature Range .....-40°C to +85°C  
 Junction Temperature .....+150°C  
 Storage Temperature Range .....-65°C to +150°C  
 Lead Temperature (soldering, 10s) ..... +300°C

Stresses beyond those listed under "Absolute Maximum Ratings" may cause permanent damage to the device. These are stress ratings only, and functional operation of the device at these or any other conditions beyond those indicated in the operational sections of the specifications is not implied. Exposure to absolute maximum rating conditions for extended periods may affect device reliability.

## DC ELECTRICAL CHARACTERISTICS

(V<sub>CC</sub> = +2.7V to +3.3V, R<sub>RBIAS</sub> = R<sub>RLNA</sub> = 24kΩ, BUFFEN = LOW, all RF and IF outputs connected to V<sub>CC</sub>, no RF applied, T<sub>A</sub> = -40°C to +85°C. Typical values are at +3.0V and T<sub>A</sub> = +25°C, unless otherwise noted. Refer to Operational Modes table for control logic.)

| PARAMETER                                     | CONDITIONS                        | MIN         | TYP  | MAX | UNITS |
|---|-----------------------------------|-------------|------|-----|-------|
| <b>PCS CDMA MODES</b>                         |                                   |             |      |     |       |
| Operating Supply Current                      | High-gain, low-linearity mode     |             | 18   | 24  | mA    |
|   | High-gain, high-linearity mode    |             | 25   | 33  |       |
| <b>CELLULAR CDMA MODE</b>                     |                                   |             |      |     |       |
| Operating Supply Current                      | Low-gain mode                     |             | 19.5 | 25  | mA    |
|   | High-gain, low-linearity mode     |             | 18   | 24  |       |
|   | High-gain, high-linearity mode    |             | 28   | 35  |       |
| <b>FM MODE</b>                                |                                   |             |      |     |       |
| Operating Supply Current                      |                                   |             | 13.5 | 17  | mA    |
| <b>SHUTDOWN MODE</b>                          |                                   |             |      |     |       |
| Shutdown Supply Current                       |                                   |             | 0.1  | 5   | μA    |
| <b>ALL MODES</b>                              |                                   |             |      |     |       |
| LO Buffer Supply Current                      | BUFFEN = HIGH                     | LO/2 = LOW  | 7.2  | 9.5 | mA    |
|   |                                   | LO/2 = HIGH | 10.3 |     |       |
| Additional Operational Current Divider Active | Cellular and FM mode; LO/2 = HIGH |             | 1.2  |     | mA    |
| Digital Input Logic High                      |                                   | 2.0         |      |     | V     |
| Digital Input Logic Low                       |                                   |             |      | 0.6 | V     |
| Digital Input High Current                    |                                   |             |      | 5   | μA    |
| Digital Input Low Current                     |                                   | -25         |      |     | μA    |

# Triple/Dual-Mode CDMA LNA/Mixers

MAX2338

## AC ELECTRICAL CHARACTERISTICS

(MAX2338 EV kit,  $V_{CC} = +2.7V$  to  $+3.3V$ ,  $f_{PLNAIN} = f_{PMIXIN} = 1930MHz$  to  $1990MHz$ ,  $f_{CLNAIN} = f_{CMIXIN} = 869MHz$  to  $894MHz$ ,  $f_{IF} = 183MHz$ , high side LO, LO/2 = LOW. All ports matched to  $50\Omega$ ,  $R_{RLNA} = R_{RBIAS} = 24k\Omega$ ,  $T_A = -40^\circ C$  to  $+85^\circ C$ . Typical values are at  $T_A = +25^\circ C$ ,  $V_{CC} = +3.0V$ , unless otherwise noted.)

| PARAMETER   | CONDITIONS                       | MIN  | TYP  | MAX  | UNITS |
|---|----------------------------------|------|------|------|-------|
| <b>OVERALL PERFORMANCE</b>                                |                                  |      |      |      |       |
| Low-Band RF Frequency Range                               |                                  | 869  |      | 894  | MHz   |
| High-Band RF Frequency Range                              |                                  | 1930 |      | 1990 | MHz   |
| Low-Band LO Frequency Range                               | After divider if active (Note 1) | 950  |      | 1100 | MHz   |
| High-Band LO Frequency Range                              | (Note 1)                         | 1750 |      | 2210 | MHz   |
| IF Frequency Range  | (Note 1)                         | 80   |      | 220  | MHz   |
| LO Input Level  |                                  | -7   | -3   | 0    | dBm   |
| <b>CELLULAR LNA PERFORMANCE</b>                           |                                  |      |      |      |       |
| <b>HIGH-GAIN, HIGH-LINEARITY MODES</b>                    |                                  |      |      |      |       |
| Gain (Note 2)   |                                  | 14.0 | 15.7 | 17.0 | dB    |
| Noise Figure (Note 3)                                     | $T_A = +25^\circ C$              |      | 1.4  | 1.6  | dB    |
| Noise Figure Change Due to Temperature                    | $T_A = +25^\circ C$ to $T_{MAX}$ |      | 0.3  |      | dB    |
| IIP3 (Notes 3, 4)   |                                  | 9.5  | 12   |      | dBm   |
| <b>CDMA HIGH-GAIN, LOW-LINEARITY MODE AND FM MODE</b>     |                                  |      |      |      |       |
| Gain (Note 2)   |                                  | 13   | 14.7 | 16.5 | dB    |
| Noise Figure (Note 3)                                     | $T_A = +25^\circ C$              |      | 1.4  | 1.7  | dB    |
| IIP3 (Note 3, 4)  |                                  | 2.5  | 5.5  |      | dBm   |
| <b>CDMA LOW-GAIN MODE</b>                                 |                                  |      |      |      |       |
| Gain (Note 2)   |                                  | -4.0 | -2.3 | 0    | dBm   |
| Noise Figure (Note 3)                                     |                                  |      | 5    | 6    | dB    |
| IIP3 (Notes 3, 4)   |                                  | 15   | 18   |      | dBm   |
| <b>PCS LNA PERFORMANCE</b>                                |                                  |      |      |      |       |
| <b>CDMA HIGH-GAIN, HIGH-LINEARITY MODE</b>                |                                  |      |      |      |       |
| Gain (Note 2)   |                                  | 13.8 | 15.3 | 16.9 | dB    |
| Noise Figure (Note 3)                                     | $T_A = +25^\circ C$              |      | 1.4  | 1.7  | dB    |
| Noise Figure Change Due to Temperature                    | $T_A = +25^\circ C$ to $T_{MAX}$ |      | 0.3  |      | dB    |
| IIP3 (Notes 3, 5)   |                                  | 5.0  | 7.7  |      | dBm   |
| <b>CDMA HIGH-GAIN, LOW-LINEARITY MODE</b>                 |                                  |      |      |      |       |
| Gain (Note 2)   |                                  | 13.0 | 14.5 | 16.5 | dB    |
| Noise Figure (Note 3)                                     | $T_A = +25^\circ C$              |      | 1.4  | 1.7  | dB    |
| IIP3 (Notes 3, 5)   |                                  | 2.5  | 7.5  |      | dBm   |
| <b>CELLULAR MIXER PERFORMANCE</b>                         |                                  |      |      |      |       |
| <b>CDMA HIGH-GAIN, HIGH-LINEARITY, AND LOW-GAIN MODES</b> |                                  |      |      |      |       |
| Gain (Note 2)   |                                  | 10.3 | 13.3 | 16.4 | dB    |
| Noise Figure (Note 3)                                     | $T_A = +25^\circ C$              |      | 7.8  | 9.0  | dB    |
| IIP3 (Note 4)   |                                  | 3.0  | 5.5  |      | dBm   |

# Triple/Dual-Mode CDMA LNA/Mixers

## AC ELECTRICAL CHARACTERISTICS (continued)

(MAX2338 EV kit,  $V_{CC} = +2.7V$  to  $+3.3V$ ,  $f_{PLNAIN} = f_{PMIXIN} = 1930MHz$  to  $1990MHz$ ,  $f_{CLNAIN} = f_{CMIXIN} = 869MHz$  to  $894MHz$ ,  $f_{IF} = 183MHz$ , high side LO, LO/2 = LOW. All ports matched to  $50\Omega$ ,  $R_{RLNA} = R_{RBIAS} = 24k\Omega$ ,  $T_A = -40^{\circ}C$  to  $+85^{\circ}C$ . Typical values are at  $T_A = +25^{\circ}C$ ,  $V_{CC} = +3.0V$ , unless otherwise noted.)

| PARAMETER                                  | CONDITIONS   | MIN                           | TYP  | MAX  | UNITS  |
|--|--|-------------------------------|------|------|--------|
| <b>HIGH-GAIN, LOW-LINEARITY IDLE MODE</b>  |  |                               |      |      |        |
| Gain (Note 2)                              |  | 10.1                          | 13   | 16   | dB     |
| Noise Figure (Note 3)                      | $T_A = +25^{\circ}C$                               |                               | 7.3  | 9.0  | dB     |
| IIP3 (Notes 3, 4)                          |  | 1.4                           | 3.5  |      | dBm    |
| <b>FM MODE</b>                             |  |                               |      |      |        |
| Gain (Note 2)                              |  | 6.0                           | 8.8  | 11.1 | dB     |
| Noise Figure (Note 3)                      | $T_A = +25^{\circ}C$                               |                               | 8.7  | 11.0 | dB     |
| IIP3 (Note 4)                              |  | 1.4                           | 3.4  |      | dBm    |
| <b>PCS MIXER PERFORMANCE</b>               |  |                               |      |      |        |
| <b>CDMA HIGH-GAIN, HIGH-LINEARITY MODE</b> |  |                               |      |      |        |
| Gain (Note 2)                              |  | 11.7                          | 14.5 | 17   | dB     |
| Noise Figure (Note 3)                      | $T_A = +25^{\circ}C$                               |                               | 7.8  | 9.0  | dB     |
| IIP3 (Notes 3, 5)                          |  | 3.5                           | 7.5  |      | dBm    |
| <b>HIGH-GAIN, LOW-LINEARITY MODE</b>       |  |                               |      |      |        |
| Gain (Note 2)                              |  | 11.2                          | 14   | 16.2 | dB     |
| Noise Figure (Note 3)                      | $T_A = +25^{\circ}C$                               |                               | 7.2  | 9.0  | dB     |
| IIP3 (Note 5)                              |  | 0.5                           | 2.5  |      | dBm    |
| <b>ALL MODES</b>                           |  |                               |      |      |        |
| Mixer Output 1dB Compression               |  |                               | -1   |      | dBm    |
| 4 x 5 Suppression (Note 6)                 |  |                               | >45  |      | dB     |
| 2 x 2 Input Intercept Point (Notes 3, 7)   |  | 25                            | 33   |      | dBm    |
| LO Output Level (Note 3)                   | Into $50\Omega$ or $100\Omega$ load, BUFFEN = HIGH | -12                           | -6   |      | dBm    |
| LO Output Leakage                          | BUFFEN = LOW                                       |                               | -35  |      | dBm    |
| LO Emission at PCS LNA Input Port          |  |                               | -55  |      | dBm    |
| LO Emission at Cellular LNA Input Port     |  |                               | -55  |      | dBm    |
| LO Output Harmonic Suppression             | BUFFEN = HIGH                                      |                               | -15  |      | dBc    |
| LO Output Noise Power                      | BUFFEN = HIGH                                      | PCS band, 80MHz below LO      |      | -161 | dBm/Hz |
|  |  | Cellular band, 45MHz below LO |      | -161 |        |
| RF Ports Return Loss                       | All active RF ports including 2-element matching   |                               | 10   |      | dB     |

**Note 1:** Operation over this frequency range may require the ports to be rematched for the desired operating frequency.

**Note 2:** MIN guaranteed by production test, MAX guaranteed by design and characterization.

**Note 3:** Guaranteed by design and device characterization.

**Note 4:** Two-tone IIP3. Tested at  $f_{RF1} = 880MHz$ ,  $f_{RF2} = 880.9MHz$ , and power =  $-25dBm/$ tone.

**Note 5:** Two-tone IIP3. Tested at  $f_{RF1} = 1960MHz$ ,  $f_{RF2} = 1961.25MHz$ , and power =  $-25dBm/$ tone.

**Note 6:**  $f_{LO} = 1064MHz$ ,  $f_{RF1} = 887.8MHz$  at  $-30dBm$ ,  $f_{RF2} = 881MHz$  at  $-100dBm$ . Performance is measured as  $P_{IF}$  due to RF1 -  $P_{IF}$  due to RF2.

**Note 7:**  $f_{LO} = 2143MHz$ ,  $f_{RF1} = 2051.5MHz$  at  $-35dBm$ ,  $f_{RF2} = 1960MHz$  at  $-100dBm$ . Performance is measured as  $P_{IF}$  due to RF1 -  $P_{IF}$  due to RF2.

# Triple/Dual-Mode CDMA LNA/Mixers

## Typical Operating Characteristics

( $T_A = +25^\circ\text{C}$ , unless otherwise noted.)

MAX2338

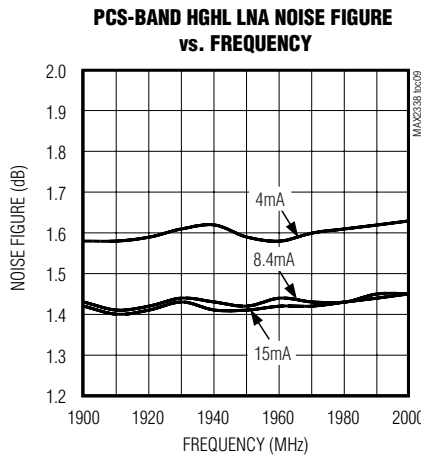
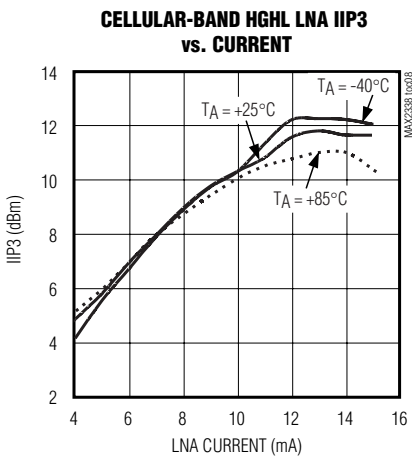
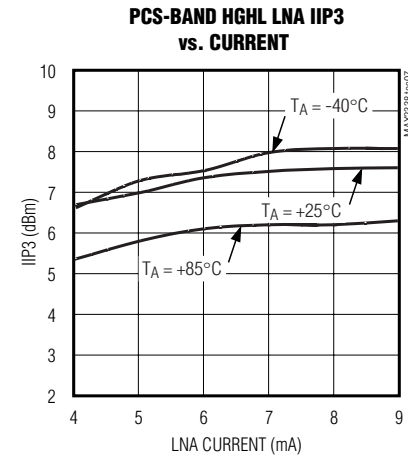
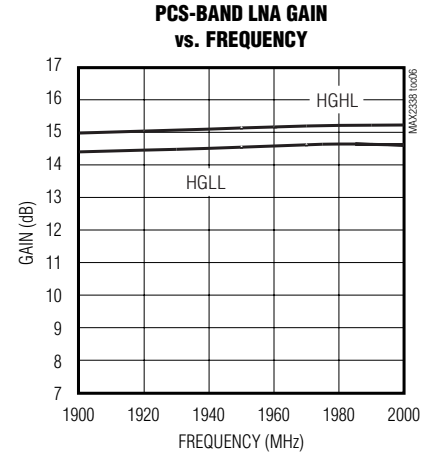
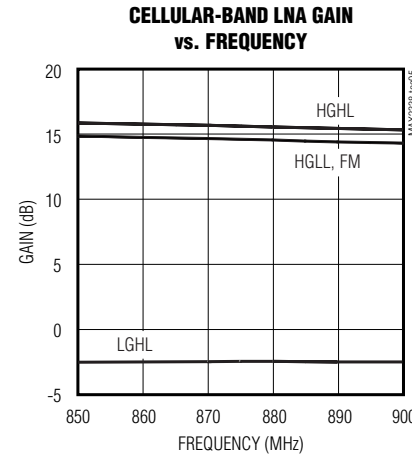
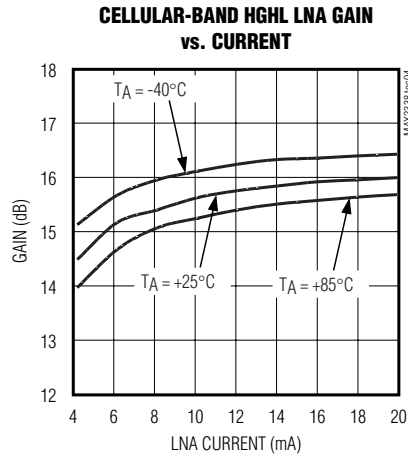
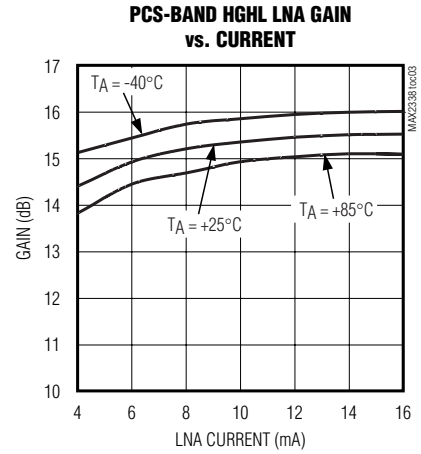
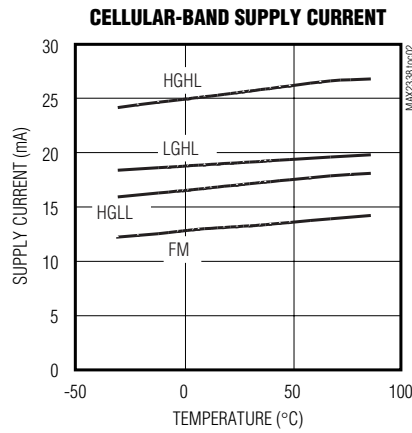
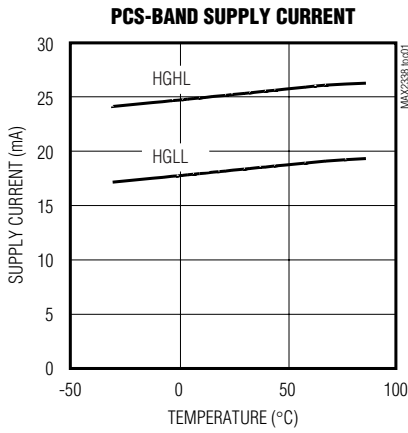

# Triple/Dual-Mode CDMA LNA/Mixers

## Typical Operating Characteristics (continued)

( $T_A = +25^\circ\text{C}$ , unless otherwise noted.)

**CELLULAR-BAND HGHL LNA NOISE FIGURE vs. FREQUENCY**

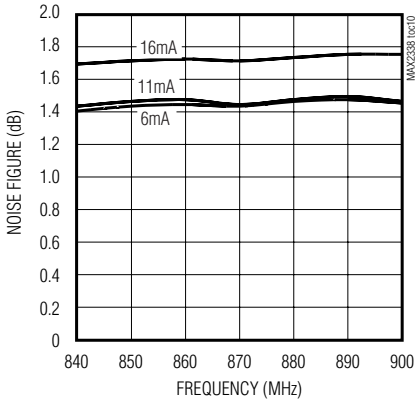

**CELLULAR-BAND HGHL MIXER CONVERSION GAIN vs. CURRENT**

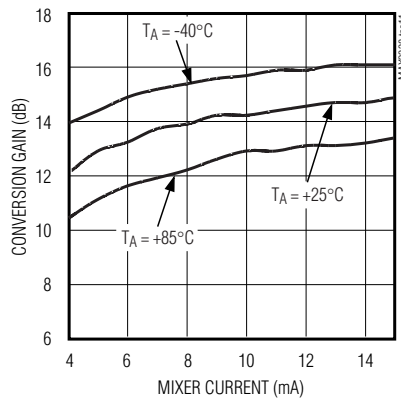

**PCS-BAND MIXER CONVERSION GAIN vs. CURRENT**

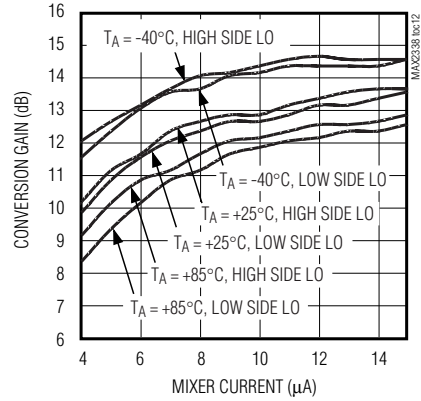

**CELLULAR-BAND MIXER CONVERSION GAIN vs. LO INPUT LEVEL**

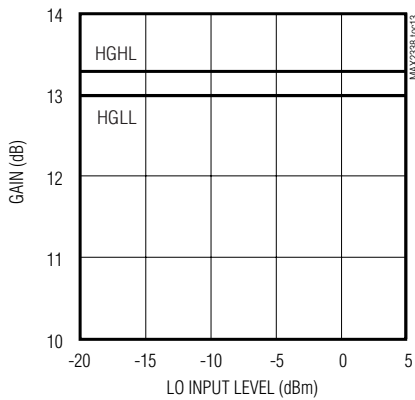

**PCS-BAND MIXER CONVERSION GAIN vs. LO INPUT LEVEL**

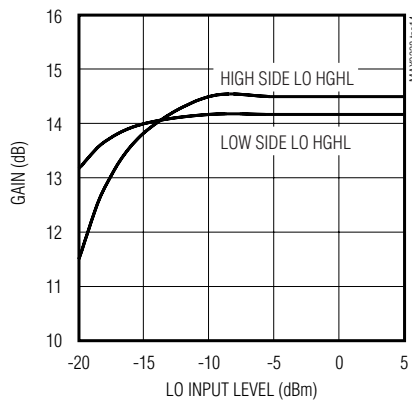

**CELLULAR-BAND MIXER CONVERSION GAIN vs. RF INPUT LEVEL**

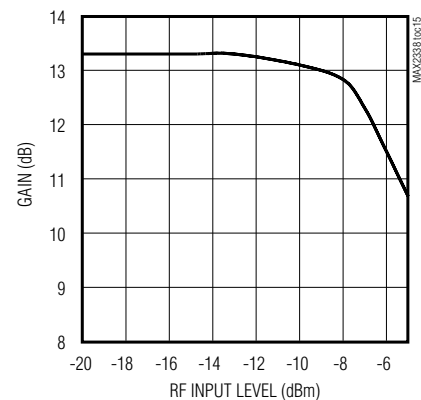

**PCS-BAND MIXER CONVERSION GAIN vs. RF INPUT LEVEL**

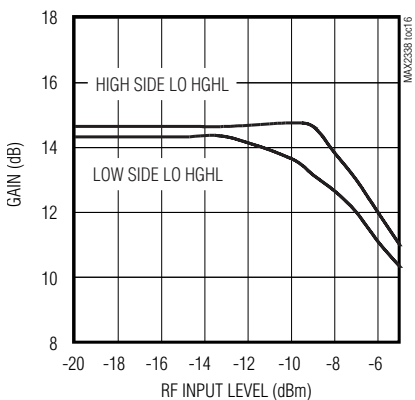

**CELLULAR-BAND HGHL MIXER IIP3 vs. CURRENT**

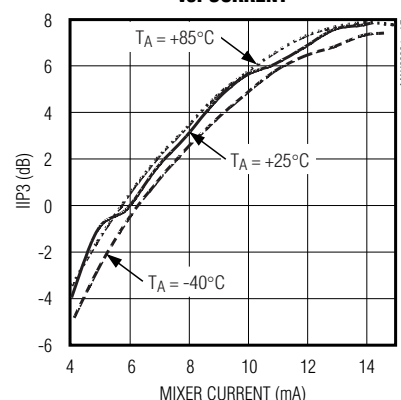

**PCS-BAND HGHL MIXER IIP3 vs. CURRENT**

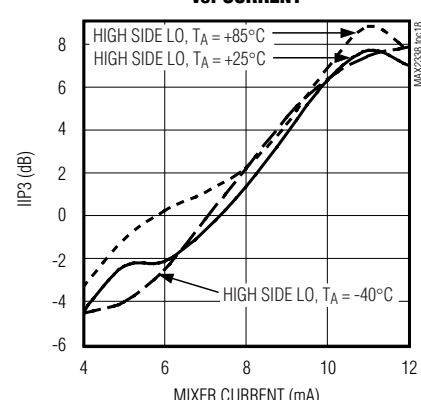

# Triple/Dual-Mode CDMA LNA/Mixers

## Typical Operating Characteristics (continued)

( $T_A = +25^\circ\text{C}$ , unless otherwise noted.)

MAX2338

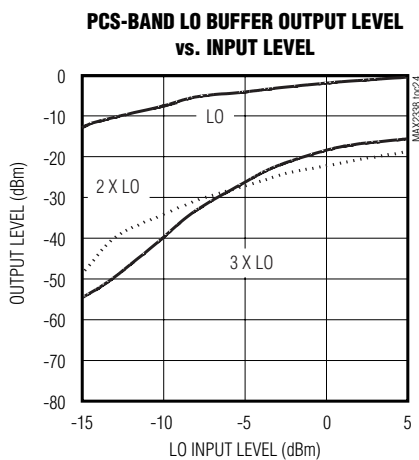
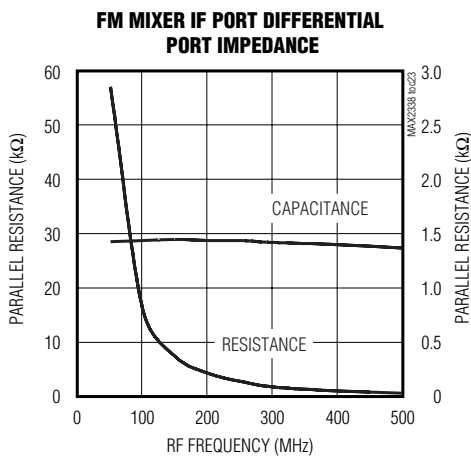
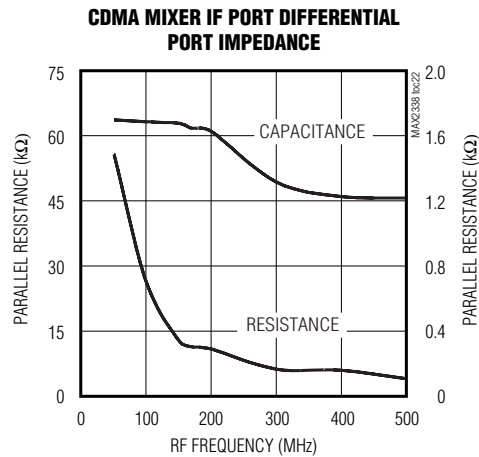
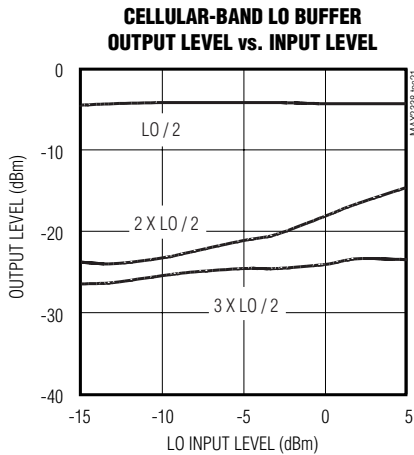
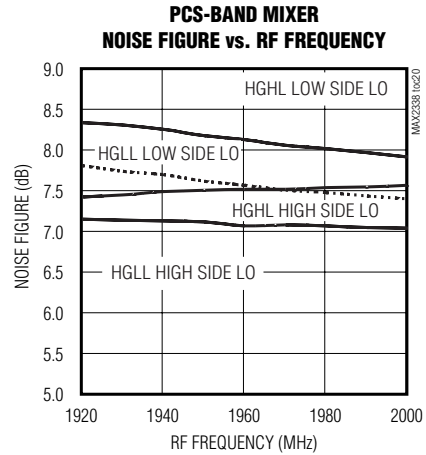
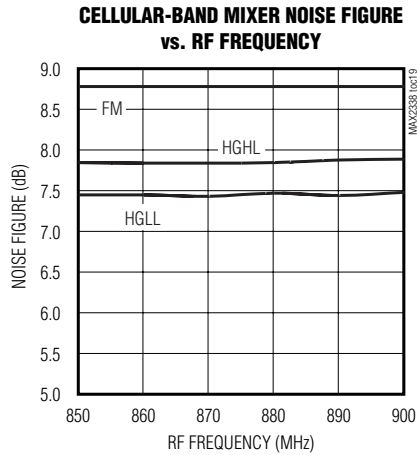

# Triple/Dual-Mode CDMA LNA/Mixers

## Pin Description

| PIN                                      | NAME                     | FUNCTION  |
|--|--------------------------|---|
| 1  | RLNA                     | LNA Bias-Setting Resistor Connection. For nominal bias, connect a 24k $\Omega$ resistor to ground. The value of this resistor sets the bias current for HGHL LNAs.  |
| 2  | PLNAIN                   | High-Band RF Input. Requires a blocking capacitor which may be used as part of the input matching network.  |
| 3, 8, 11, 18, 24, 25, 27, Exposed Paddle | GND                      | Ground Reference for RF, DC and Logic Inputs. Solder the exposed paddle evenly to the circuit board ground plane.   |
| 4  | CLNAIN                   | Low-Band RF Input. Requires a blocking capacitor which may be used as part of the input matching network.   |
| 5  | $\overline{\text{BAND}}$ | Band-Select Logic Input. LOW selects high-band (PCS), HIGH selects low-band (cellular).   |
| 6  | LIN                      | Linearity-Select Logic Input. See <i>Detailed Description</i> for control modes.  |
| 7  | GAIN                     | Gain-Select Logic Input. See <i>Detailed Description</i> for control modes.   |
| 9  | LO/2                     | LO Divider-Select Input. LOW disables LO divider, HIGH selects divider in cellular and FM modes. See <i>Detailed Description</i> for control modes.   |
| 10                                       | LOIN                     | LO Input Port. Requires an external DC blocking capacitor.  |
| 12                                       | PLOOUT                   | PCS LO Buffer Output Port. Internally matched to 100 $\Omega$ (nominal). Does not require a blocking capacitor.   |
| 13                                       | CLOOUT                   | Cell LO Buffer Output Port. Internally matched to 100 $\Omega$ (nominal). Does not require a blocking capacitor. The output frequency is one half LOIN when LO/2 is floating or HIGH, and equal to LOIN when LO/2 is LOW. |
| 14                                       | NC                       | No Connection   |
| 15                                       | FMOUT                    | FM Mixer Output Port. Requires pullup inductor and DC blocking capacitor, which may be used as part of the output matching network.   |
| 16                                       | VCC                      | Power Supply Pin. Bypass with capacitor as close to the pin as possible.  |
| 17                                       | BUFFEN                   | LO Output Buffer Enable. Drive BUFFEN HIGH to power up the LO output buffer associated with the selected band.  |
| 19, 20                                   | IF-, IF+                 | Mixer Differential Outputs. Require pullup inductors and series capacitors which can be used as part of the output matching network.  |
| 21                                       | RBIAS                    | Bias Setting Resistor Connection. For nominal bias, connect a 24k $\Omega$ resistor to ground. The value of this resistor sets current for all blocks except HGHL LNA.  |
| 22                                       | CMIXIN                   | Low-Band Mixer Input. Requires a blocking capacitor which may be used as part of the input matching network.  |
| 23                                       | PMIXIN                   | High-Band Mixer Input. Requires a blocking capacitor which may be used as part of the input matching network.   |
| 26                                       | PLNAOUT                  | High-Band LNA Output Port. Connect a pullup inductor to VCC and an external series blocking capacitor which may be used as a part of the output matching network.   |
| 28                                       | CLNAOUT                  | Low-Band LNA Output Port. Connect a pullup inductor to VCC and an external series blocking capacitor which may be used as a part of the output matching network.  |



# Triple/Dual-Mode CDMA LNA/Mixers

MAX2338

## Detailed Description

The MAX2338 consists of cellular band and PCS band (LNAs) and mixers. The IC also consists of a local oscillator (LO) divider and LO buffers for cellular and PCS bands.

### Low-Noise Amplifiers

The MAX2338 LNAs' gain and linearity are switched by the GAIN and LIN input, respectively. The PCS band LNA has two operational modes: high-gain high-linearity (HGHL) and high-gain low-linearity (HGLL). The cellular band LNA has three operational modes: HGHL, HGLL, and low-gain high-linearity (LGHL) modes. The table in the *Operational Modes* section shows the pin settings for BAND, GAIN, and LIN for various operating modes. Use HGHL mode when extra high linearity is required for cross-modulation suppression, HGLL mode when the transmitter is off and cross-modulation is not a concern, and LGHL mode when receiving large signals.

### Downconverter

The downconverters in these devices are double balanced mixers. The PCS band mixer and digital cellular band mixer share the same IF output ports. The cellular

FM band mixer has its own IF output to feed to a different filter. When the linearity requirement is high, the LIN control input increases the current in the downconverter. The downconverter requires a DC blocking capacitor at the input and output, and a pullup inductor at the output. The DC blocking capacitors can be designed to be part of the matching circuits. The table in the *Operational Modes* section shows the settings for BAND, GAIN, and LIN for various operating modes.

### LO Output Buffers

There are two LO output buffers: cellular and PCS. The inputs are tied together and internally matched to 50Ω. The outputs of the PCS and cellular buffers are brought out separately. The outputs of the buffers are internally matched and include a DC blocking capacitor.

### LO Divider

The MAX2338 includes an LO divider circuit which enables a single VCO for both cellular and PCS bands. The LO/2 logic input turns the divider on or off in the cellular band.

Table 1. Operational Modes

| MODES   | FUNCTION   |      |       |          |          |          |               |               |          | CONTROL PIN |      |     |      |
|---|------------|------|-------|----------|----------|----------|---------------|---------------|----------|-------------|------|-----|------|
|   | BAND (H/L) | LOX1 | LO /2 | HGHL Amp | HGLL Amp | LGHL Amp | CDMA HL Mixer | CDMA LL Mixer | FM Mixer | BAND        | GAIN | LIN | LO/2 |
| PCS Band, High-Gain, High-Linearity (HGHL)                      | H          | ✓    |       | ✓        |          |          | ✓             |               |          | 0           | 1    | 1   | X    |
| PCS Band, High-Gain, Low-Linearity (Idle Mode) (HGLL)           | H          | ✓    |       |          | ✓        |          |               | ✓             |          | 0           | 1    | 0   | X    |
| Undefined   | —          | —    | —     | —        | —        | —        | —             | —             | —        | 0           | 0    | 1   | X    |
| Cellular Band CDMA, High-Gain, High-Linearity (HGHL)            | L          |      | ✓     | ✓        |          |          | ✓             |               |          | 1           | 1    | 1   | 1    |
| Cellular Band CDMA, High-Gain, Low-Linearity (Idle Mode) (HGLL) | L          |      | ✓     |          | ✓        |          |               | ✓             |          | 1           | 1    | 0   | 1    |
| Cellular Band, CDMA, Low-Gain                                   | L          |      | ✓     |          |          | ✓        | ✓             |               |          | 1           | 0    | 1   | 1    |
| Cellular Band, FM Mode  | L          |      | ✓     |          | ✓        |          |               |               | ✓        | 1           | 0    | 0   | 1    |
| Cellular Band CDMA, High-Gain, High-Linearity (HGHL)            | L          | ✓    |       | ✓        |          |          | ✓             |               |          | 1           | 1    | 1   | 0    |
| Cellular Band CDMA, High-Gain, Low-Linearity (Idle Mode) (HGLL) | L          | ✓    |       |          | ✓        |          |               | ✓             |          | 1           | 1    | 0   | 0    |
| Cellular Band, CDMA, Low-Gain                                   | L          | ✓    |       |          |          | ✓        | ✓             |               |          | 1           | 0    | 1   | 0    |
| Cellular Band, FM Mode  | L          | ✓    |       |          | ✓        |          |               |               | ✓        | 1           | 0    | 0   | 0    |
| Shutdown  |            |      |       |          |          |          |               |               |          | 0           | 0    | 0   | X    |

# Triple/Dual-Mode CDMA LNA/Mixers

## Operational Modes

The various operating modes are controlled by the logic inputs BAND, GAIN, LIN, and LO/2. Table 1 shows the pin settings for the various operating modes.

## Applications Information

### Cascaded LNA/Mixer Performance

The LNA and mixer design optimizes cascaded performance in all gain and linearity modes. In HGHL mode both the LNA and mixer have a low noise figure, high gain, and high linearity. The LNA has high gain to mini-

mize the noise contribution of the mixer, thus increasing the receiver's sensitivity, and the LNA has high linearity for cross-modulation suppression. The HGHL mode is used when the transmitter is off and cross-modulation is not a concern. In LGHL mode, the received signal is strong enough that linearity is the primary concern. The LNA gain is reduced for higher system linearity.

### S-Parameters

Use the S-parameters listed in the following tables to design the RF matching circuits.

**Table 2. MAX2338 Cellular Band LNA S-parameters High-Gain, High-Linearity Mode**

| FREQUENCY (MHz) | S <sub>11</sub> | ∠S <sub>11</sub> | S <sub>21</sub> | ∠S <sub>21</sub> | S <sub>12</sub> | ∠S <sub>12</sub> | S <sub>22</sub> | ∠S <sub>22</sub> |
|-----------------|-----------------|------------------|-----------------|------------------|-----------------|------------------|-----------------|------------------|
| 30              | 0.905           | -5.4             | 0.145           | -38              | 0.002           | -55              | 0.98            | -47              |
| 50              | 0.899           | -8.1             | 0.467           | -57              | 0.003           | -126             | 0.94            | -72              |
| 100             | 0.891           | -15.1            | 1.34            | -86              | 0.012           | -174             | 0.96            | -117             |
| 150             | 0.884           | -21.8            | 2.2             | -108             | 0.023           | 176              | 0.96            | -144             |
| 200             | 0.874           | -28.2            | 2.83            | -127             | 0.027           | 165.8            | 0.95            | -162             |
| 300             | 0.85            | -41.6            | 3.77            | -157.5           | 0.029           | 137              | 0.93            | -172             |
| 400             | 0.818           | -52.5            | 4.24            | 178.3            | 0.030           | 127              | 0.90            | 155              |
| 500             | 0.785           | -63.5            | 4.44            | 155.4            | 0.036           | 112              | 0.94            | 129              |
| 600             | 0.75            | -71.6            | 4.38            | 140              | 0.040           | 98               | 0.87            | 100              |
| 700             | 0.714           | -79.8            | 4.16            | 125              | 0.048           | 90               | 0.84            | 78               |
| 800             | 0.683           | -76.5            | 4.03            | 112.6            | 0.059           | 83.0             | 0.793           | 67.5             |
| 810             | 0.681           | -77.0            | 4.01            | 111.2            | 0.060           | 82.8             | 0.798           | 66.5             |
| 820             | 0.677           | -77.0            | 3.99            | 110.0            | 0.061           | 82.0             | 0.800           | 65.7             |
| 830             | 0.675           | -78.0            | 3.97            | 108.5            | 0.061           | 80.9             | 0.799           | 65.0             |
| 840             | 0.670           | -78.3            | 3.96            | 107.2            | 0.062           | 80.6             | 0.792           | 64.2             |
| 850             | 0.668           | -78.8            | 3.93            | 106.4            | 0.063           | 79.2             | 0.782           | 63.4             |
| 860             | 0.665           | -79.0            | 3.92            | 104.7            | 0.063           | 78.1             | 0.769           | 62.7             |
| 870             | 0.661           | -79.5            | 3.91            | 103.4            | 0.063           | 77.2             | 0.753           | 61.8             |
| 880             | 0.660           | -80.0            | 3.89            | 102.1            | 0.063           | 76.5             | 0.733           | 60.6             |
| 890             | 0.660           | -80.4            | 3.87            | 100.8            | 0.063           | 75.4             | 0.710           | 59.4             |
| 900             | 0.653           | -81.0            | 3.86            | 99.3             | 0.063           | 73.5             | 0.690           | 57.7             |
| 1000            | 0.614           | -97.0            | 3.59            | 86.2             | 0.07            | 20               | 0.680           | 51.8             |
| 1250            | 0.547           | -111             | 3.15            | 60.8             | 0.09            | -13.2            | 0.650           | 37               |
| 1500            | 0.457           | -131             | 2.93            | 34               | 0.109           | -36              | 0.610           | 15.9             |
| 1750            | 0.310           | -164             | 2.48            | 18               | 0.14            | -62              | 0.580           | -9.6             |
| 2000            | 0.320           | 166              | 2.1             | -40              | 0.185           | -98              | 0.490           | -33              |
| 2500            | 0.300           | 141              | 1.62            | -41              | 0.19            | -150             | 0.360           | -70              |
| 3000            | 0.310           | 122              | 1.29            | -66              | 0.19            | 136              | 0.41            | -64              |
| 3500            | 0.360           | 86               | 1.18            | -88              | 0.2             | 90               | 0.500           | -61              |
| 4000            | 0.360           | 10               | 1.14            | -112             | 0.2             | 43               | 0.480           | -50              |

# Triple/Dual-Mode CDMA LNA/Mixers

MAX2338

## Layout Considerations

Keep RF signal lines as short as possible to minimize losses and radiation. Use high Q components for the LNA input-matching circuit to achieve the lowest possible noise figure. At the digital mixer outputs, keep the differential signal lines together and of equal length to ensure signal balance. For best gain and noise performance, solder the exposed paddle evenly to the board ground plane.

**Table 3. MAX2338 PCS Band LNA S-Parameters High-Gain, High-Linearity Mode**

| FREQUENCY (MHz) | S11   | ∠S11  | S21   | ∠S21  | S12   | ∠S12 | S22   | ∠S22 |
|-----------------|-------|-------|-------|-------|-------|------|-------|------|
| 30              | 0.890 | -4.9  | 0.002 | -95   | 0.001 | -112 | 0.996 | -48  |
| 50              | 0.883 | -7.2  | 0.001 | -60   | 0.001 | -121 | 0.990 | -73  |
| 100             | 0.872 | -13.2 | 0.391 | -81   | 0.002 | -178 | 0.980 | -114 |
| 200             | 0.841 | -25   | 0.882 | -112  | 0.007 | 171  | 0.970 | -150 |
| 300             | 0.799 | -35   | 1.42  | -131  | 0.010 | 150  | 0.959 | -166 |
| 400             | 0.778 | -41   | 2.1   | -153  | 0.02  | 125  | 0.947 | -173 |
| 600             | 0.750 | -62   | 2.15  | -172  | 0.02  | 100  | 0.943 | 173  |
| 800             | 0.706 | -75   | 2.2   | 162   | 0.025 | 80   | 0.944 | 151  |
| 1000            | 0.676 | -85   | 2.45  | 150   | 0.029 | 65   | 0.919 | 133  |
| 1200            | 0.659 | -94   | 2.59  | 142   | 0.032 | 42   | 0.879 | 115  |
| 1500            | 0.634 | -108  | 3.03  | 134   | 0.036 | 31   | 0.824 | 94.4 |
| 1750            | 0.578 | -110  | 3.58  | 126   | 0.038 | 19   | 0.780 | 81   |
| 1900            | 0.560 | -90.8 | 3.64  | 120.6 | 0.04  | 11.8 | 0.740 | 61.7 |
| 1910            | 0.558 | -91.0 | 3.64  | 119.6 | 0.04  | 9.06 | 0.738 | 60.7 |
| 1920            | 0.554 | -91.4 | 3.64  | 118.9 | 0.04  | 8.8  | 0.733 | 59.6 |
| 1930            | 0.551 | -91.7 | 3.63  | 118.2 | 0.04  | 6.7  | 0.729 | 58.5 |
| 1940            | 0.547 | -92.2 | 3.63  | 117.7 | 0.04  | 5.3  | 0.725 | 57.4 |
| 1950            | 0.543 | -92.2 | 3.63  | 117.0 | 0.04  | 4.87 | 0.720 | 56.1 |
| 1960            | 0.538 | -92.4 | 3.63  | 116.5 | 0.04  | 4.1  | 0.716 | 55.0 |
| 1970            | 0.536 | -92.5 | 3.61  | 115.9 | 0.04  | 1.8  | 0.716 | 53.6 |
| 1980            | 0.533 | -92.9 | 3.60  | 115.2 | 0.04  | 1.5  | 0.711 | 52.3 |
| 1990            | 0.530 | -93.0 | 3.59  | 114.7 | 0.04  | 0    | 0.707 | 50.9 |
| 2000            | 0.523 | -93.4 | 3.57  | 113.0 | 0.04  | -2.1 | 0.702 | 49.5 |
| 2250            | 0.347 | -155  | 2.88  | 131   | 0.05  | -32  | 0.518 | 24   |
| 2500            | 0.298 | -158  | 2.71  | 172   | 0.05  | -72  | 0.489 | 5    |
| 3000            | 0.273 | -160  | 2.64  | -165  | 0.06  | -94  | 0.473 | -18  |
| 4000            | 0.245 | -170  | 2.03  | -145  | 0.067 | -120 | 0.425 | -30  |

# Triple/Dual-Mode CDMA LNA/Mixers

**MAX2338**

**Table 4. MAX2338 Cellular Band Mixer Input S-Parameters High-Gain, High-Linearity Mode**

| FREQUENCY (MHz) | S <sub>11</sub> | ∠S <sub>11</sub> |
|-----------------|-----------------|------------------|
| 800             | 0.843           | -67.5            |
| 810             | 0.843           | -68.2            |
| 820             | 0.842           | -68.8            |
| 830             | 0.842           | -69.5            |
| 840             | 0.843           | -70.2            |
| 850             | 0.843           | -71.0            |
| 860             | 0.843           | -71.6            |
| 870             | 0.843           | -72.4            |
| 880             | 0.842           | -73.0            |
| 890             | 0.841           | -74.0            |
| 900             | 0.840           | -75.0            |

**Table 5. MAX2338 PCS Band Mixer Input S-Parameters High-Gain, High-Linearity Mode**

| FREQUENCY (MHz) | S <sub>11</sub> | ∠S <sub>11</sub> |
|-----------------|-----------------|------------------|
| 1900            | 0.762           | -76.9            |
| 1910            | 0.759           | -77.8            |
| 1920            | 0.755           | -79.0            |
| 1930            | 0.752           | -80.1            |
| 1940            | 0.747           | -81.2            |
| 1950            | 0.744           | -82.2            |
| 1960            | 0.741           | -83.2            |
| 1970            | 0.739           | -84.3            |
| 1980            | 0.734           | -85.5            |
| 1990            | 0.730           | -86.7            |
| 2000            | 0.723           | -87.9            |

# Triple/Dual-Mode CDMA LNA/Mixers

## Typical Operating Circuit

**MAX2338**

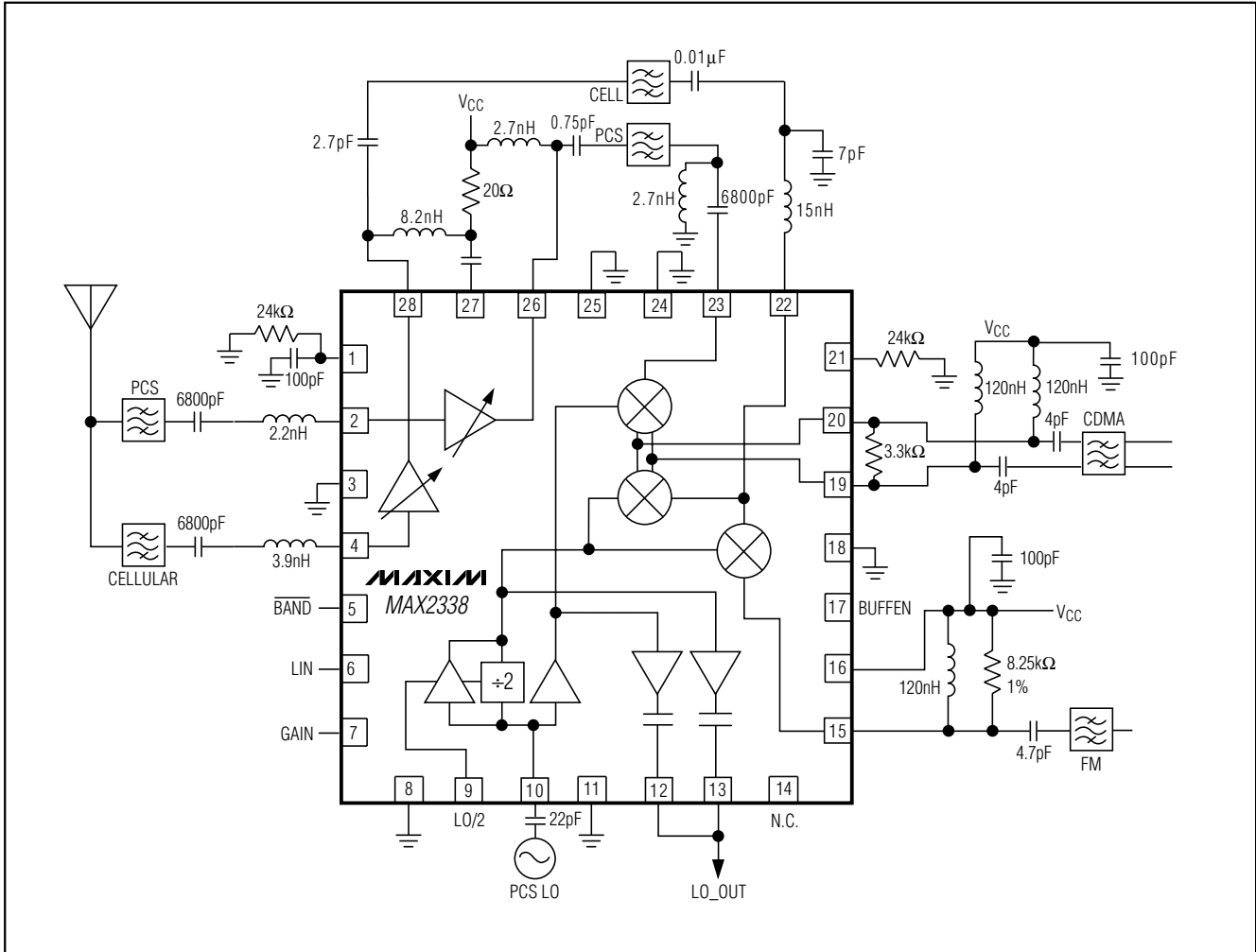

## Package Information

For the latest package outline information, go to [www.maxim-ic.com/packages](http://www.maxim-ic.com/packages).

Maxim cannot assume responsibility for use of any circuitry other than circuitry entirely embodied in a Maxim product. No circuit patent licenses are implied. Maxim reserves the right to change the circuitry and specifications without notice at any time.

Maxim Integrated Products, 120 San Gabriel Drive, Sunnyvale, CA 94086 408-737-7600 13